



SIEMENS EDA

# Getting Started With ODB+ +Design Cadence<sup>®</sup> Allegro<sup>®</sup> Edition

Release vNPI 2403  
March 2024

Unpublished work. © 2024 Siemens

This Documentation contains trade secrets or otherwise confidential information owned by Siemens Industry Software Inc. or its affiliates (collectively, "Siemens"), or its licensors. Access to and use of this Documentation is strictly limited as set forth in Customer's applicable agreement(s) with Siemens. This Documentation may not be copied, distributed, or otherwise disclosed by Customer without the express written permission of Siemens, and may not be used in any way not expressly authorized by Siemens.

This Documentation is for information and instruction purposes. Siemens reserves the right to make changes in specifications and other information contained in this Documentation without prior notice, and the reader should, in all cases, consult Siemens to determine whether any changes have been made.

No representation or other affirmation of fact contained in this Documentation shall be deemed to be a warranty or give rise to any liability of Siemens whatsoever.

If you have a signed license agreement with Siemens for the product with which this Documentation will be used, your use of this Documentation is subject to the scope of license and the software protection and security provisions of that agreement. If you do not have such a signed license agreement, your use is subject to the Siemens Universal Customer Agreement, which may be viewed at <https://www.sw.siemens.com/en-US/sw-terms/base/uca/>, as supplemented by the product specific terms which may be viewed at <https://www.sw.siemens.com/en-US/sw-terms/supplements/>.

SIEMENS MAKES NO WARRANTY OF ANY KIND WITH REGARD TO THIS DOCUMENTATION INCLUDING, BUT NOT LIMITED TO, THE IMPLIED WARRANTIES OF MERCHANTABILITY, FITNESS FOR A PARTICULAR PURPOSE, AND NON-INFRINGEMENT OF INTELLECTUAL PROPERTY. SIEMENS SHALL NOT BE LIABLE FOR ANY DIRECT, INDIRECT, INCIDENTAL, CONSEQUENTIAL OR PUNITIVE DAMAGES, LOST DATA OR PROFITS, EVEN IF SUCH DAMAGES WERE FORESEEABLE, ARISING OUT OF OR RELATED TO THIS DOCUMENTATION OR THE INFORMATION CONTAINED IN IT, EVEN IF SIEMENS HAS BEEN ADVISED OF THE POSSIBILITY OF SUCH DAMAGES.

TRADEMARKS: The trademarks, logos, and service marks (collectively, "Marks") used herein are the property of Siemens or other parties. No one is permitted to use these Marks without the prior written consent of Siemens or the owner of the Marks, as applicable. The use herein of third party Marks is not an attempt to indicate Siemens as a source of a product, but is intended to indicate a product from, or associated with, a particular third party. A list of Siemens' Marks may be viewed at: [www.plm.automation.siemens.com/global/en/legal/trademarks.html](http://www.plm.automation.siemens.com/global/en/legal/trademarks.html). The registered trademark Linux® is used pursuant to a sublicense from LMI, the exclusive licensee of Linus Torvalds, owner of the mark on a world-wide basis.

### **About Siemens Digital Industries Software**

Siemens Digital Industries Software is a global leader in the growing field of product lifecycle management (PLM), manufacturing operations management (MOM), and electronic design automation (EDA) software, hardware, and services. Siemens works with more than 100,000 customers, leading the digitalization of their planning and manufacturing processes. At Siemens Digital Industries Software, we blur the boundaries between industry domains by integrating the virtual and physical, hardware and software, design and manufacturing worlds. With the rapid pace of innovation, digitalization is no longer tomorrow's idea. We take what the future promises tomorrow and make it real for our customers today. Where today meets tomorrow. Our culture encourages creativity, welcomes fresh thinking and focuses on growth, so our people, our business, and our customers can achieve their full potential.

Support Center: [support.sw.siemens.com](http://support.sw.siemens.com)

Send Feedback on Documentation: [support.sw.siemens.com/doc\\_feedback\\_form](http://support.sw.siemens.com/doc_feedback_form)

# Table of Contents

---

<b>Chapter 1</b>	
<b>Before You Start.....</b>	<b>7</b>
List of ODB++ Inside for Cadence Allegro Documents.....	7
<b>Chapter 2</b>	
<b>Basic Tasks for Working With Product Models.....</b>	<b>9</b>
Configuring the Display.....	9
Zooming and Panning.....	15
Measuring Distances.....	17
Measuring Between Two Distant Points.....	20
Viewing Component and Feature Information.....	20
Using the Component Filter Pane to Find Components.....	23
Using the Components Histogram to Select or Highlight Components.....	25
Using the Features Histogram to Select or Highlight Features.....	28
<b>Chapter 3</b>	
<b>General Reference.....</b>	<b>31</b>
Shortcuts to Graphic Area Functions.....	32
Mouse Button Codes.....	32
Graphic Area Shortcuts.....	32
Control Dialog Box Shortcuts.....	33
Zoom and Display Shortcuts.....	34
Feature and Component Selection Actions.....	35
Snap Hot Keys.....	37
Matrix Shortcuts.....	37
Layer Parameters.....	38
Layer Subtypes.....	41
Standard Layer Subtypes.....	41
Layer Attributes.....	43
<b>Chapter 4</b>	
<b>GUI Reference.....</b>	<b>47</b>
Matrix Window.....	48
Control Dialog Box.....	51
Component Information Dialog Box.....	56
Colors Dialog Box.....	60
Feature Information Dialog Box.....	63
Component Display Options Dialog Box.....	69
Features Histogram Dialog Box.....	73
Snap Dialog Box.....	76
View Orientation Dialog Box.....	81

**Chapter 5**  
**Troubleshooting..... 83**  
    Text Scaling Issues on Windows 10..... 83  
    Display Colors are Not Correct..... 83  
    Profile is Not Visible in Graphic Area..... 84

**Glossary of Valor NPI Terms**

**Glossary of Electronics Industry Terms**

# List of Tables

---

Table 1. Mouse Button Codes.....	32
Table 2. Graphic Area Shortcuts.....	32
Table 3. Control Dialog Box Shortcuts.....	34
Table 4. Zoom and Display Shortcuts.....	34
Table 5. Feature Selection Shortcuts.....	35
Table 6. Select by Rectangle Shortcuts.....	36
Table 7. Selection by Polygon Shortcuts.....	36
Table 8. Selection by Net Shortcuts.....	36
Table 9. Snap Shortcut Keys.....	37
Table 10. Matrix Actions Menu Shortcuts.....	37
Table 11. Key Combinations and Mouse Options for Layer View Navigation.....	38
Table 12. Colors Dialog Box - Entity Pane.....	61
Table 13. Colors Dialog Box - Color Picker Pane.....	61
Table 14. Colors Dialog Box - Action Buttons.....	61
Table 15. Feature Information - Pad.....	66
Table 16. Features Histogram Dialog Box.....	74
Table 17. Items to Which Snapping Applies.....	77
Table 18. Snap Modes.....	77
Table 19. Feature Snap Points Per Snap Mode.....	78
Table 20. Grid Display.....	79
Table 21. Snap Dialog Box.....	80



# Chapter 1

## Before You Start

---

This document contains general reference information and describes how to perform basic tasks while working with product models. The product model is the main entity of the ODB++Design format, (also referred to as “ODB++D” or “ODB++”). The product model stores all information about an electronic product as an open, ASCII file structure.

---



### Tip

You can download for free the ODB++Design format specification at <https://odbplusplus.com/design>.

---

[List of ODB++ Inside for Cadence Allegro Documents](#)

## List of ODB++ Inside for Cadence Allegro Documents

Online Help provides documentation for all areas of the ODB++ Inside functionality. To access the user documentation from within your installed application, choose **Help > Online Help** or press F1.

Document	Description
<i>Valor ODB++ for Cadence Allegro</i>	Generating ODB++Design output from Cadence Allegro.
<i>ODB++ Viewer User Guide</i>	The ODB++ Viewer interface enables you to interactively review ODB++Design product models.





# Chapter 2

## Basic Tasks for Working With Product Models

---

Use the instructions in this section to customize the display, navigate the graphic area, as well as search for features and components based on their information.

[Configuring the Display](#)

[Zooming and Panning](#)

[Measuring Distances](#)

[Measuring Between Two Distant Points](#)

[Viewing Component and Feature Information](#)

[Using the Component Filter Pane to Find Components](#)

[Using the Components Histogram to Select or Highlight Components](#)

[Using the Features Histogram to Select or Highlight Features](#)

## Configuring the Display

A properly configured display is essential for the successful completion of your NPI tasks. You can control the mouse pointer appearance, customize colors of various entities, and set display options for components, features, layers, profiles, dynamic texts, and dimensions. You can specify update modes for the Popup and histogram windows, as well as set units of measure in which distance values are displayed.

### Procedure

1. Customize the colors in which the layers, background, rubberband, and selected and highlighted items are displayed in the graphic area:

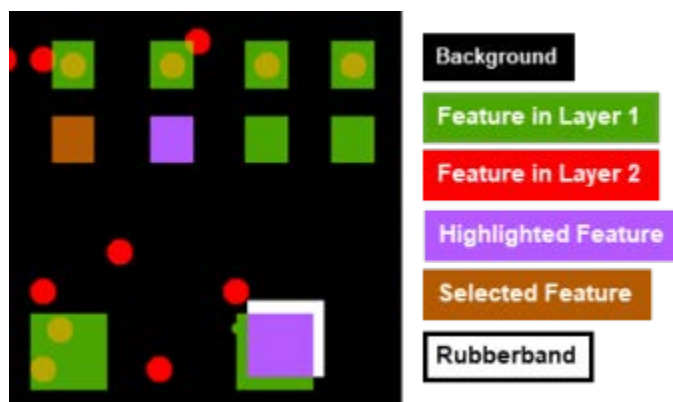

- a. Open the Colors dialog box as appropriate for the application you are using.
- b. Use one of the following methods to set colors:

If you want to...	Do the following:
Define colors for entities	<p>For each entity whose color you want to define, do the following:</p> <ol style="list-style-type: none"> <li>i. In the Entity pane, select the entity for which you want to define a color: Layer 1 - Layer 25, Background, Highlight, Select, or Rubberband.</li> <li>ii. In the Color Picker pane, select a color.</li> </ol> <p> <b>Tip</b> For best results, use a dark color for the background, bright colors for layer features and components, and light colors for Rubberband, Highlight, and Select.</p> <ol style="list-style-type: none"> <li>iii. Click <b>Apply</b>.</li> </ol>
Load a color scheme	<p>Prerequisite: A color scheme file exists.</p> <ol style="list-style-type: none"> <li>i. Click <b>Load</b>.</li> <li>ii. Navigate to the directory in which you store color scheme files.</li> <li>iii. Select the color scheme file and click <b>Open</b>.</li> <li>iv. Click <b>Apply</b>.</li> </ol>

c. (Optional) Save the color scheme:

- i. Click **Save**.
- ii. Navigate to the directory in which you store your color scheme files.
- iii. Name the file and click **Save**.

d. Click **OK** to apply the colors and close the dialog box.



**Note:**

If you do not save the color scheme before checking in the product model, the scheme will revert to the last saved scheme or to system default colors, if there is no saved scheme.

---



**Note:**

The colors of overlapping objects in different displayed layers are mixed.

---





**Note:**

The colors of Select, Highlight, and Rubberband are mixed with the layer colors or cover them.

---

2. Configure how data is displayed in the graphic area:

- a. Open the Control dialog box as appropriate for the application you are using.
- b. Specify how features are depicted by selecting one of the following Width options:
  - **On** —  
  - **Outline** —  
  - **Off** —  
- c. Specify whether negative data is dimmed or clear (erasing positive data).
- d. Consider whether you want the color of a recently displayed layer to override underlying colors. If so, set Layer Display Mode to Opaque.

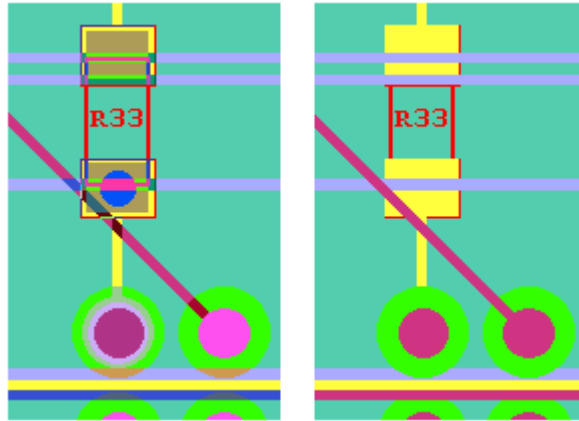

- e. To display only Step & Repeat outlines used in panelization and hide all features of selected layers, set Step & Repeat Features Display to No.
- f. Specify whether to display drills and rout data as pads or markers.
- g. Specify whether to show the translated value of embedded code when displaying dynamic texts or show only the code label.
- h. Set the units of measurement for displaying distance values to Inch/mils or mm/microns.
- i. If you want the Popview window to update continuously, set Popview Continuous Mode to On.
- j. If you want the Features Histogram to update continuously, set Features Histogram Auto Update to Yes.
- k. If you want the Slots Histogram to update continuously, set Slots Histogram Auto Update to Yes.
- l. Set Graphic Cursor to Regular or Full Screen.
- m. Specify whether to display chain layer features.
- n. Specify whether to display the compensated rout layer in the Rout Profile Editor.

- o. Set Dimension Msg Display to Yes if you want to display Rout Profile Editor messages reporting invalid dimension links when source or destination elements are modified.
- p. To display Flow Solder and SMT direction indicators in the Overview pane, set FS & SMT Direction Display to Yes.

Outline arrows indicate Flow Solder direction and solid arrows indicate SMT direction. T = top; B = bottom.

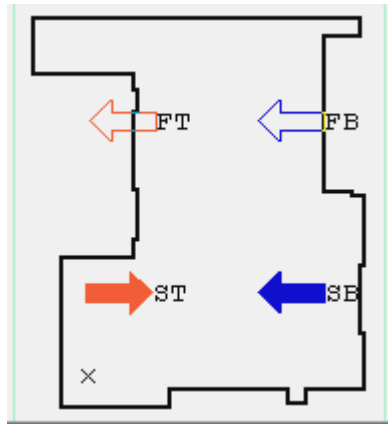

- FT — Flow solder top
  - FB — Flow solder bottom
  - ST — SMT top
  - SB — SMT bottom
- q. Set Layer Profile Display to one of the following: Yes (grid of dots), Outline (dotted line indicating the outline of the layer profile), or No.

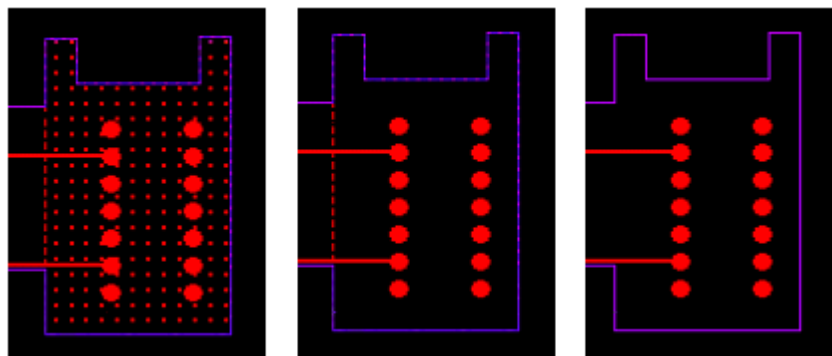

- r. Set Layer Zone Display to one of the following: Yes (solid color for rigid zones, pattern for flex zone), Outline (solid line indicating the outline of layer zones), or No.

Layer Zone Display = Yes



- s. Specify whether to show or hide the layer features that are completely outside of the profile of the Step & Repeat elements inside a panel.
  - t. Close the dialog box.
3. If the Component Display Options dialog box is available, use it to set the component display options:
- a. Select the appropriate Name Display option: RefDes, None, Manufacturer/MPN, CAD Part, CPN, VPL Pkg, Package, IPN, BOM Pkg.
  - b. Set Font Size to 36, 30, or 24.
  - c. Consider whether you want the text to extend beyond the component and lead outline. If so, select Yes under Overflow Text.
  - d. If you want to display component leads, select the appropriate Show Pins option: Mount, Lead Edges, Lead Form, Geometry, Name, Extended Lead Form, Net.



**Note:**

If the pin name of the package differs from that on the component, and Package is selected in Name Display, the pin name displayed is that of the package and an X is displayed on the pin.

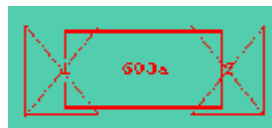

**Note:**

If the pin is non-electrical, M (mechanical) is displayed on it. X indicates that the component includes recommended pins.

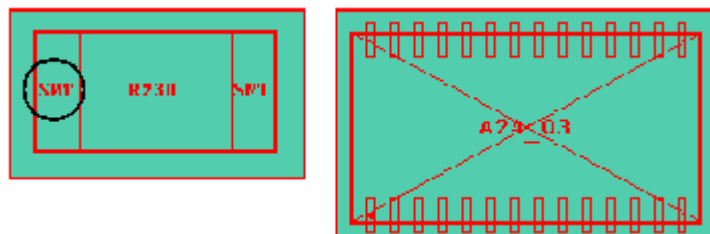

- e. (Prerequisite: Show Pins ≠ No) Select Yes to display the Pin #1 mark on component leads.

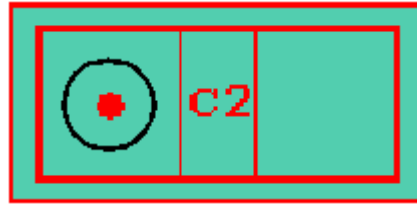

f. If you want to hide components that bear the .comp\_ignore attribute, set Components Display to “Placed Only”.

g. Define the component outline as Body, Envelope, or T-envelope:

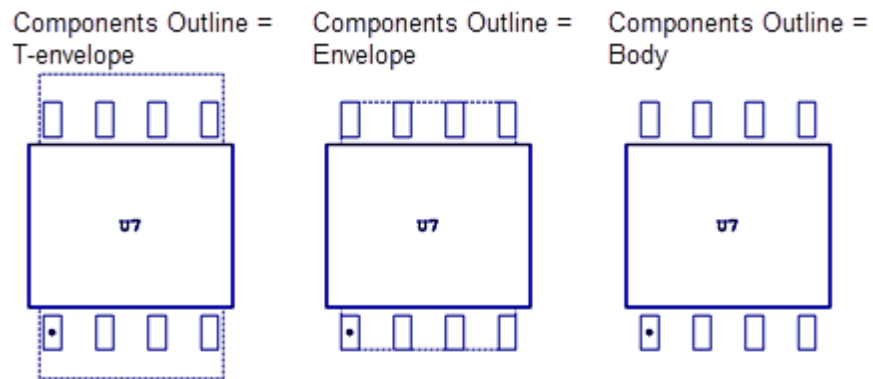

---

**i** **Tip**  
To better view spacing measurements, select the Envelope or T-envelope option.

---

h. To highlight component data before merging with VPL data, in addition to the VPL data, set Pre-VPL Component Display to Yes.

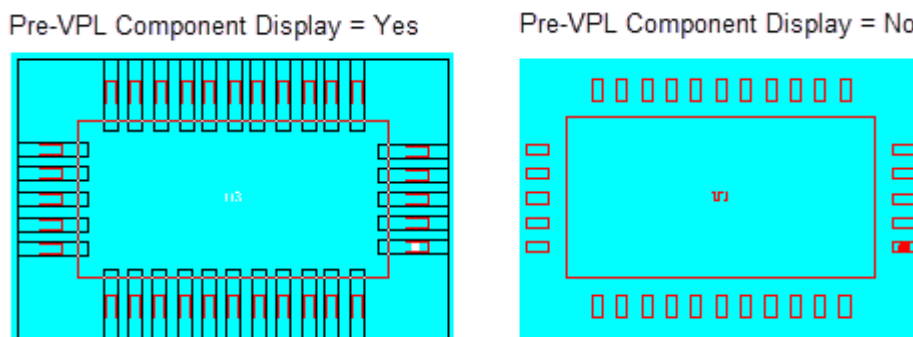

i. (Optional) Click **Set as Default** to save the settings as the default.

j. Click **Close** to close the dialog box.

## Related Topics

[Colors Dialog Box](#)

[Control Dialog Box](#)







[Component Display Options Dialog Box](#)





# Zooming and Panning

You can use the menus, the toolbars, the mouse wheel, or the right mouse button to zoom in or out of a specific point in the graphic area, to zoom to a specific area of the board, or to zoom home. In addition, you can use the mouse wheel to pan to the center of the graphic area, and the right mouse button to open the Control dialog box or undo a previous action. Some ODB++Design interfaces support the moving of the center of the graphic area to specific coordinates and a magnified popview display of a section of the board.

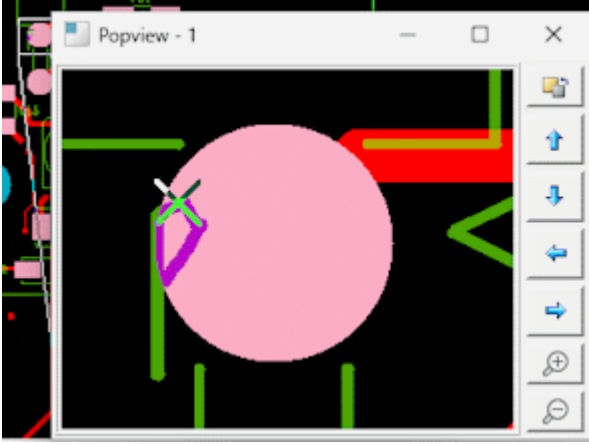

## Procedure

1. Use the following actions to explore and interact with ODB++Design content:

If you want to...	Do one of the following:
Zoom out	<ul style="list-style-type: none"> <li>• Choose <b>View &gt; Zoom Out</b>.</li> <li>• Click the <b>Zoom Out</b> tool ().</li> <li>• Right-drag diagonally up and to the right ().</li> <li>• Roll the mouse wheel up.</li> <li>• Shift-click the mouse wheel.</li> </ul>
Zoom in	<ul style="list-style-type: none"> <li>• Choose <b>View &gt; Zoom In</b>.</li> <li>• Click the <b>Zoom In</b> tool ().</li> <li>• Right-drag diagonally down and to the left ().</li> <li>• Roll the mouse wheel down.</li> <li>• Click the mouse wheel.</li> </ul>
Zoom to area	<ul style="list-style-type: none"> <li>• Choose <b>View &gt; Zoom Area</b> and draw a rectangle around the section of interest in the graphic area.</li> <li>• Click the <b>Zoom Area</b> tool () and draw a rectangle around the section of interest in the graphic area.</li> <li>• Right-drag diagonally down and to the right, so that the start and end of the line you drag define the rectangular area to which you want to zoom ().</li> </ul>

If you want to...	Do one of the following:
	<ul style="list-style-type: none"> <li>• (If available) Use the popview display to magnify sections of the board:                             <ol style="list-style-type: none"> <li>i. Click the <b>Popview</b> tool (  ).</li> <li>ii. Draw a rectangle around the section of the graphic area you want to display in the popview.</li> <li>iii. Draw a second rectangle to define the popview window.</li> </ol> <p>You can move this rectangle to a convenient location. You can enlarge or shrink it.</p> <p>The rectangular section of the graphic area is displayed in the popview window.</p>  <p>The corners of the two rectangles are connected by lines.</p> <ol style="list-style-type: none"> <li>iv. (Optional) Change the area displayed in the popview by dragging the source rectangle.</li> <li>v. (Optional) Repeat Steps 2 through 4 for each section of the board you want to magnify.</li> <li>vi. (Optional) Print the last opened popview display by pressing Ctrl-P.</li> <li>vii. (Optional) To close the popview and display the area in the Editor, click <b>Goto Editor and Zoom</b> (  ) on the Popview window.</li> </ol> </li> </ul>
Zoom home	<ul style="list-style-type: none"> <li>• Choose <b>View &gt; Zoom Home</b>.</li> <li>• Click the <b>Zoom Home</b> tool (  ).</li> <li>• Right-drag on the diagonal up and to the left (  ).</li> <li>• Ctrl-click the mouse button. A second Ctrl-click returns to the previous view.</li> </ul>

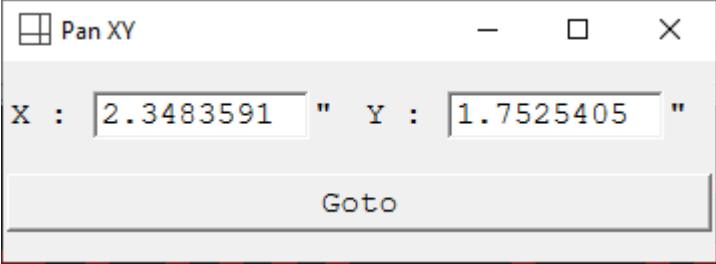

If you want to...	Do one of the following:
Pan	<ul style="list-style-type: none"> <li>Click the appropriate pan tool:                             <div data-bbox="846 338 1135 405" style="text-align: center;">  </div> </li> <li>Drag the mouse wheel in the direction you want to pan.</li> </ul>
Move the center of the graphic area to specific coordinates	<ol style="list-style-type: none"> <li>Choose <b>View &gt; Pan XY</b> or click . The Pan XY dialog box opens.                             <div data-bbox="634 569 1346 831" style="text-align: center;">  </div> </li> <li>Type the X and Y coordinates to be the center of the graphic area.</li> <li>Click <b>Goto</b>.</li> </ol>

2. (Optional) To cancel the most recent action, right-drag up, right, and down ()

## Related Topics

[Zoom and Display Shortcuts](#)



# Measuring Distances





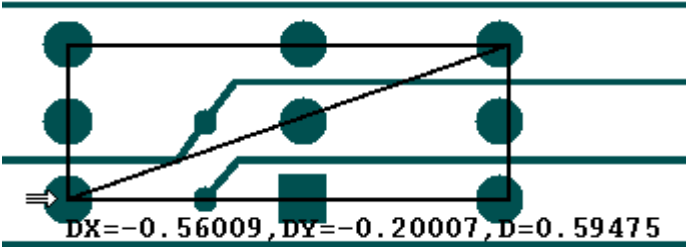

You can display orthogonal and diagonal measurements between points on the same, or different, layers by clicking one of the tools for measuring distances, and the respective start and end points.

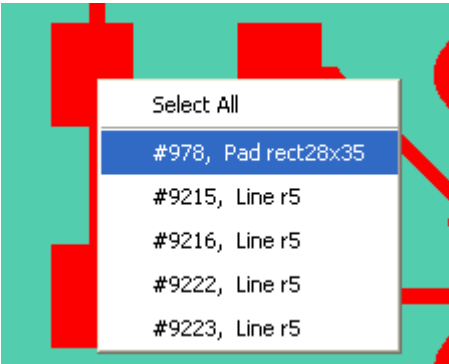
## Procedure

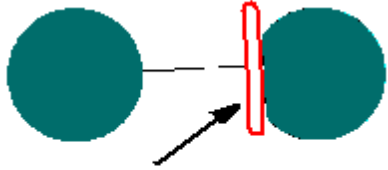
- From the Layer List, display the layers containing the features or components between which you want to measure the distance.
- Click one of the measuring tools and select the respective points, by using one of these options:

If you want to...	Do the following:
Measure the distance between two points	 <b>Tip</b> It is convenient, and more accurate, to set Snap mode before measuring.

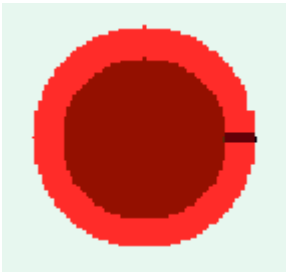
If you want to...	Do the following:
	<ol style="list-style-type: none"> <li>1. Click the <b>Measure Between Points</b> tool (  ) and click the first point. A measurement rubberband opens, displaying DX, DY values.</li> <li>2. Click the second point. The distance between the two points is displayed in the Data Bar.</li> </ol>  <p>The example shows:</p> <ul style="list-style-type: none"> <li>• DX=0.56009 (relative distance along the X axis)</li> <li>• DY=0.20007 (relative distance along the Y axis)</li> <li>• D=0.59475 (direct distance between the two points)</li> </ul>
<p>Measure the distance between two contours/features</p>	<p> <b>Note:</b> Both features must be in the current Work Layer. To measure the distance between features from two different layers, set the first layer as the Work layer and choose the first feature. Then set the other layer as the Work layer and choose the second feature.</p> <ol style="list-style-type: none"> <li>1. Click the <b>Measure Between Contours/Features</b> tool (  ) and click the first feature.</li> <li>2. If several features overlap at that location, select the specific feature from the list.</li> </ol>  <ol style="list-style-type: none"> <li>3. Click the second feature.</li> <li>4. If several features overlap at that location, select the specific feature from the list.</li> </ol> <p>A measurement segment opens between the features. The measurement is displayed below the graphic area in the Data Bar.</p> <p>This measures the actual distance between edges of the copper existing between two features. If, for example, a pad has been shaved, this</p>

If you want to...	Do the following:
	<p>measures between the real edges of the copper, ignoring the negative (shave) feature.</p>  <p>Negative feature used in shave</p>
<p>Measure the distance between the closest points in two nets</p>	<p> <b>Note:</b> The selected nets must be closer than 100 mils.</p> <ol style="list-style-type: none"> <li>1. Select No Zoom, Auto Zoom and Pan, or Pan Only.</li> <li>2. Click the <b>Measure Between Nets</b> tool () and click a feature in one net.</li> <li>3. Click a feature in another net.</li> </ol>
<p>Measure the annular ring</p>	<p>The following procedure measures the width of an annular ring between a feature in the Work layer (typically a drill layer) and a larger, containing feature in another layer.</p> <ol style="list-style-type: none"> <li>1. Set the layer containing the smaller feature as the Work layer.</li> <li>2. Click the <b>Measure Annular Ring</b> tool () and click once on the smaller feature.</li> </ol> <p>A measuring line is displayed, and the size, along with the names of the layers, is displayed in the Data Bar.</p>  <p> <b>Note:</b> If you display more than two layers, the option measures between the feature in the Work layer relative to all the other layers (such as to the solder mask or the outer layer).</p>

## Related Topics

[Measuring Between Two Distant Points](#)

[Shortcuts to Graphic Area Functions](#)

[Snap Dialog Box](#)

## Measuring Between Two Distant Points

Measuring the distance between two points far from each other might require that you change the zoom factor.

### Procedure

1. Zoom to the first point.
2. Click the **Measurement between points** button (  ) on the application toolbar.
3. Click the first point to start measurement.

Its coordinates display in the data bar.

```
DX=-0.0107527,DY=0.0026882,D=0.0110836
```

4. Press Home to display the whole layer, and place the mouse approximately over the second point.

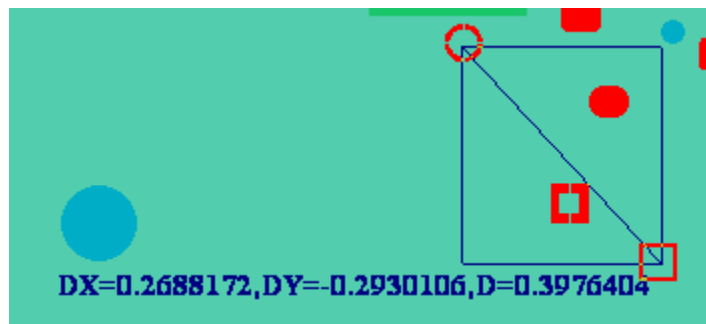

5. Press Ctrl-E to center the second point in the graphic area.
  6. Press Page Down repeatedly until the image is enlarged sufficiently.
  7. Click the second point.
- Its coordinates and the value of the measurement display in the data bar.

```
DX=0.266129,DY=-0.2930106,D=0.3958281
```

### Related Topics

[Measuring Distances](#)

## Viewing Component and Feature Information

You can use the data bar or the corresponding Information window to view information about an item selected or highlighted in the graphic area.

## Procedure

1. Select or highlight an item in the graphic area.

Information for the item is displayed in the data bar (see the examples below).

If you select more than one feature or component, the data bar shows either the details of the previously selected item, or the details of the currently selected item.

2. (Optional, CAM Compare and ODB++ Viewer) In the data bar, right-click and choose the **Select All** popup menu item, or drag to select a section of the text in the data bar, and copy the selected text as necessary.
3. (Optional, Graphic Station and Panel Designer) Shift-click the data bar to view a log of all component/feature selections in the current session:

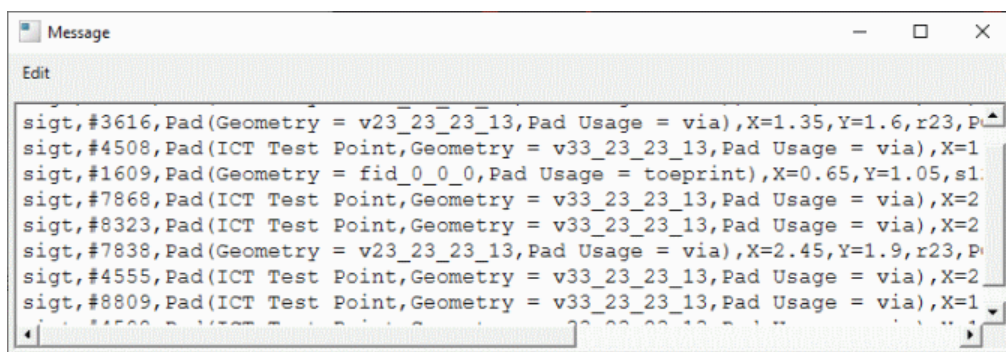

4. (Optional) Open the respective Info window to view additional details about the selected item. You can select and copy the information in the Information dialog box as necessary.
5. (Optional) If active, click the **View image/Datasheet** button () to view the component's data on the manufacturer's website.

## Examples

### Component Information In the Data Bar

```
TOP #321 U24 Part: 4100-0001 Pkg: BGA_1760_1MM 1760 Pins X=6.6929134 Y=1.5748031 L=1.6929134 W=1.6929134 H=0.137795
```

TOP #321 U24 Part: 4100-0001 Pkg: BGA\_1760\_1MM 1760 Pins X=6.6929134 Y=1.5748031  
L=1.6929134 W=1.6929134 H=0.137795 Rot=180.0 P=0.0393701

Where:

- Layer = TOP
- Index number = 321
- RefDes = U24
- Part number (CAD) = 4100-0001

- Package name (CAD) = BGA\_1760\_.1MM
- Lead count = 1760
- X (coordinate) = 6.6929134
- Y (coordinate) = 1.5748031
- Length = 1.6929134
- Width = 1.6929134
- Height = 0.137795
- Rotation = 180.0
- Pitch = 0.0393701

## Feature Information in the Data Bar

```
plane_1,#8390,Pad(SMD Pad,Geometry = REC70X70,Pad Usage = toepoint,Padstack ID = 36420),X=4.5034488,Y=1.1658425,s70,POS
```

plane\_1,#8390,Pad(SMD Pad,Geometry = REC70X70,Pad Usage = toepoint,Padstack ID = 36420),X=4.5034488,Y=1.1658425,s70,POS Net=GND COMP=J14 PIN=4 PIN\_TYPE=UU

Where:

- Layer = plane\_1
- Index number = 8390
- Feature type = Pad
- (Attribute) Geometry = REC70X70
- (Attribute) Pad Usage = toepoint
- (Attribute) Padstack ID = 36420
- X (coordinate) = 4.5034488
- Y (coordinate) = 1.1658425
- Symbol = s70
- Polarity = POS

- Net = GND
- Component = J14
- (Component) Lead count = 4
- (Component) Lead type = UU



**Note:**

Component and lead information is displayed only for features with a net property that are the result of conversion of primitives describing the layout of the component leads. Running the Board Merge action enables you to obtain the component and lead information for a feature that does not have a net associated with it, assuming that there are netpoints to all toeprints.

---

## Related Topics

[Component Information Dialog Box](#)

[Feature Information Dialog Box](#)

[Shortcuts to Graphic Area Functions](#)

# Using the Component Filter Pane to Find Components

The Component Filter tool is used to isolate and view components by their most commonly used criteria (RefDes, CPN, IPN, MPN, Package, VPL package, and pin name). The filtering options you specify in the tool determine the selection of components in the specified layers.



## Procedure

1. Choose **Edit > Find Component** or click the **Find Component** tool () in the toolbar.

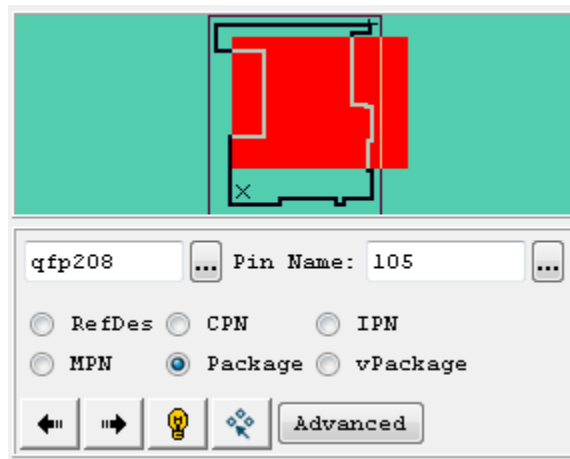

The Component Filter is displayed under the Overview area.



**Note:**

The **Select All** () , **Highlight All** () , and **Advanced** buttons are only available when you access the Component Filter pane from the Graphic Station.

---

- (Optional) In the layer list, select the component layers to which the search should apply. If no component layer is selected, the search applies to both top and bottom layers.
- Select the component identifier to be used (RefDes, CPN, IPN, MPN, Package, or vPackage).  
In the example, components are highlighted according to their Package name.
- Type or select the specific component identifier you want to find.  
In the example, components with Package name qfp208 are highlighted.
- (Optional) To view a specific lead of the component, select its name from the list.
- Click the forward arrow to view the first component that meets the criteria.  
If Pin Name is left blank, clicking the forward arrow zooms the view to and highlights the first component that meets the criteria.  
If Pin Name is specified, clicking the forward arrow zooms the view to and highlights the specific lead of the first component that meets the criteria.
- Continue clicking the forward arrow to view all components that meet the criteria.
- (Graphic Station only) To select all components that meet the criteria, click the **Select All** button () .  
In the example, all components of Package qfp208 are selected.
- (Graphic Station only) To highlight all components that meet the criteria, click the **Highlight All** button () .



In the example, all components of Package qfp208 are highlighted.

10. (Optional, Graphic Station only) Click the **Advanced** button to set more extensive search criteria in the Components Filter dialog box.

## Using the Components Histogram to Select or Highlight Components

You can use the Components Histogram to select or highlight all instances of a component in the graphic area.

### Procedure

1. Right-click a component layer in the Layer List and choose **Components Histogram**.  
The Components Histogram window opens.

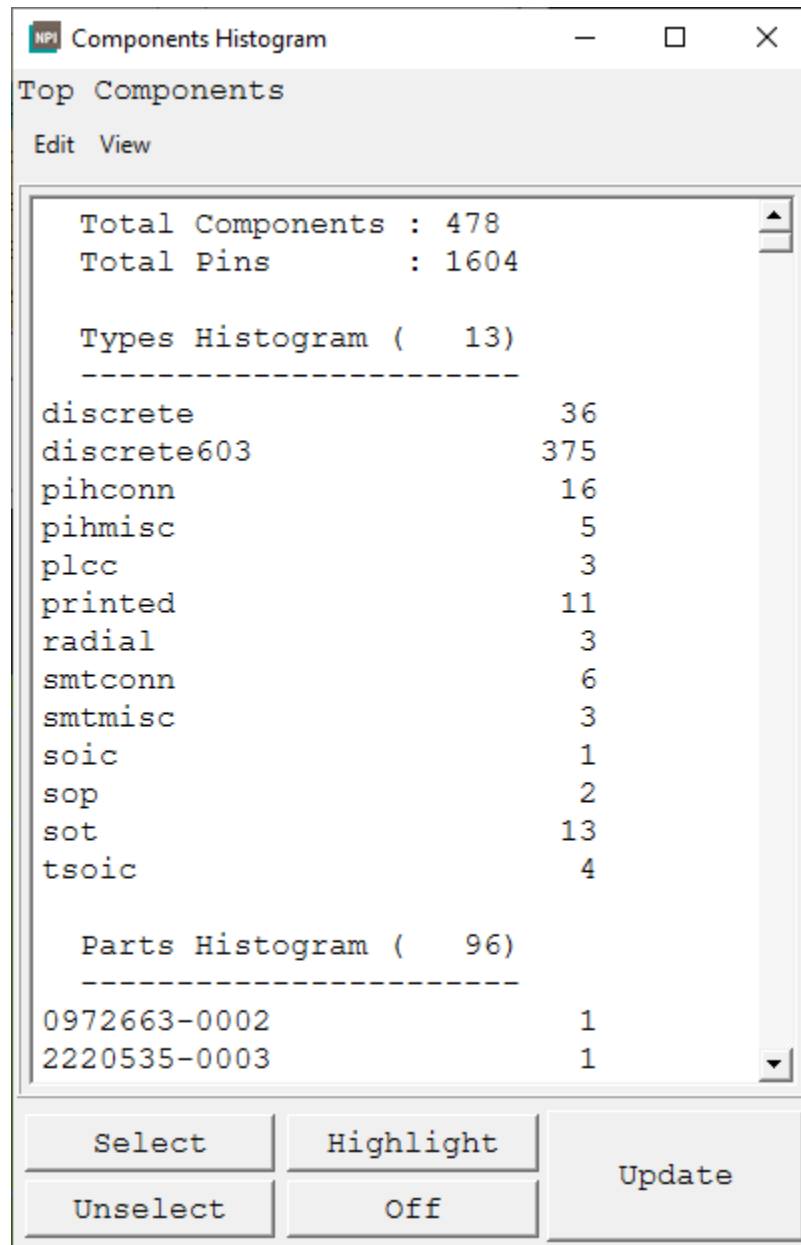

**Note:**

The **Select** and **Unselect** buttons are available only when the selected layer is an Affected layer or Work layer.

---

The Components Histogram shows the total number of components and leads in the layer, and the number of components of each type.

The list of components in the Components Histogram is divided into sections:

Section	Description
Types Histogram	Lists types of components and the number of each type. Types are defined by the <code>_comp_type</code> user attribute or by the Type2 or Type1 system attribute.
Parts Histogram	Lists part names as read from the EDA system.
CAD Packages Histogram	Lists CAD package names as read from the EDA system.
Nets Histogram	Lists nets (which have toeprints in the selected component layer) and the number of toeprints of each net.
CPNs Histogram	(BOM INFORMATION) Lists Customer Part Numbers.
IPNs Histogram	(BOM INFORMATION) Lists Internal Part Numbers.
Manufacturer/MPNs Histogram	(BOM INFORMATION) Lists Manufacturer part Numbers and their manufacturer names.
VPL Packages Histogram	(BOM INFORMATION) Lists VPL packages, each name beginning with an asterisk (*).
BOM Packages Histogram	(BOM INFORMATION) Lists BOM packages.

You can use the options on the View menu to move between the sections. For example, choose **View > Parts** to view the Parts section.

2. Perform the required action.

If you want to...	Do the following:
Locate a component	<p>Choose <b>Edit &gt; Search</b> (Ctrl-S).</p> <p>In the Search Pattern dialog box, type the reference name of a component (or a part of the name).</p> <p>Click the forward and backward arrows until the required component name is selected in the Components Histogram.</p>
Jump to a specific line	<p>Choose <b>Edit &gt; Go to Line</b> (Ctrl-G).</p> <p>In the Goto Line dialog box, type the number of the line to find, and click <b>Go</b>.</p> <p>The mouse pointer moves to the specified line.</p>
Select components	<p>Perform the appropriate task.</p> <ul style="list-style-type: none"> <li>• To select all components of a single type, click on the node in the tree and click <b>Select</b>.</li> <li>• To select components of a range of component types, drag the mouse pointer over a range of nodes, or use shift-click to mark a range of nodes, and click <b>Select</b>.</li> <li>• To select dispersed nodes, shift-click each node and click <b>Select</b> for each additional node.</li> </ul>

If you want to...	Do the following:
	The data bar displays the number of selected components.
Highlight components	<p>The Highlight function provides graphical information only and does not “select” the marked components.</p> <p>To highlight components in the graphic area, perform the appropriate task.</p> <ul style="list-style-type: none"> <li>• To highlight all components of a single type, click on the node in the tree and click <b>Highlight</b>.</li> <li>• To highlight components of a range of component types, drag the mouse pointer over a range of nodes, or use shift-click to mark a range of nodes, and click <b>Highlight</b>.</li> <li>• To highlight dispersed nodes, shift-click each node and click <b>Highlight</b> for each additional node.</li> </ul> <p>The data bar displays the number of highlighted components.</p>
Refresh the list	To refresh the list in the histogram, if components have been added to or deleted from the graphic area, click <b>Update</b> .
Deselect a component	To deselect a component in the graphic area, mark the component in the Component Histogram, and click <b>Unselect</b> .
Remove the highlight	To remove the highlight from a component in the graphic area, mark the component in the Component Histogram, and click <b>Turn Off</b> .

## Using the Features Histogram to Select or Highlight Features

Applicable layer types: Standard, Drill, Rout

Each feature node in the features histogram represents all features of the same type (such as line or pad) and polarity (POS or NEG) and symbol type (such as r18). You can select one or more feature nodes and then perform an action on all features represented by those nodes (such as select or highlight).

### Procedure

1. Open the Features Histogram dialog box as appropriate for the tool you are using.

The Features Histogram dialog box opens.

2. Make sure that the selected layer is an Affected layer or Work layer.
3. Perform the required actions:

If you want to...	Do the following:
Locate a specific type of features	<ol style="list-style-type: none"> <li>1. Choose <b>Edit &gt; Search</b> (Ctrl-S).</li> </ol> <p>The Search Pattern dialog box opens.</p>

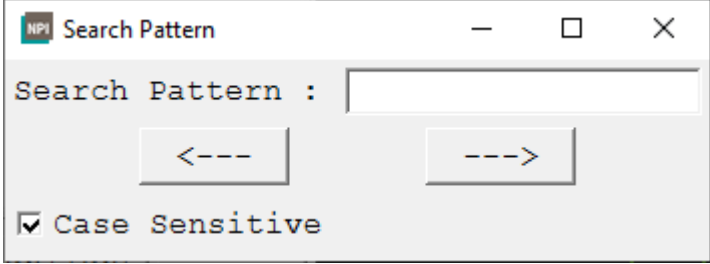
If you want to...	Do the following:
	 <ol style="list-style-type: none"> <li>(Optional) Select the Case Sensitive option.</li> <li>In the Search Pattern field, type the name of a feature or a part of the name.</li> <li>Click <b>Zoom in on previous measurement</b> (&lt;--), <b>Zoom in on next measurement</b> (--&gt;).</li> </ol> <p>The node of the histogram that contains the string is highlighted.</p>
Select features of the specified types	<ol style="list-style-type: none"> <li>Use one of the following methods to select features of the specified types: <ul style="list-style-type: none"> <li>To select all features of a single type, click the node in the tree and click <b>Select</b>.</li> <li>To select features of a range of feature types, drag the mouse pointer over a range of nodes, or use shift-click to mark a range of nodes, and click <b>Select</b>.</li> <li>To select dispersed records, shift-click each node and click <b>Select</b> for each additional node.</li> </ul> <p>The data bar displays the number of selected features.</p> </li> <li>(Optional) Repeat Step 1 to add additional feature types to selection.</li> <li>(Optional) Click <b>Unselect</b> to remove from selection the type of features to which the last selection action was applied.</li> <li>(Optional) Right-click in the graphic area and choose the <b>Clear Select &amp; Highlight</b> popup menu item to clear all selected and highlighted features.</li> </ol>
Highlight features of the specified types	<ol style="list-style-type: none"> <li>Do one of the following: <ul style="list-style-type: none"> <li>To highlight all features of a single type, click on the node in the tree and click <b>Highlight</b>.</li> <li>To highlight features of a range of feature types, drag the mouse pointer over a range of nodes, or use shift-click to mark a range of nodes, and click <b>Highlight</b>.</li> <li>To highlight dispersed records, shift-click each node and click <b>Highlight</b> for each additional node.</li> </ul> <p>The data bar displays the number of highlighted features.</p> </li> <li>(Optional) Click <b>Turn Off</b> to clear features to which the last highlight action was applied.</li> <li>(Optional) Right-click in the graphic area and choose the <b>Clear Select &amp; Highlight</b> popup menu item to clear all selected and highlighted features.</li> </ol>

Basic Tasks for Working With Product Models  
Using the Features Histogram to Select or Highlight Features

---

If you want to...	Do the following:
Refresh the Features tree	Click <b>Update</b> . The list is updated according to the currently existing features.
Expand the Features tree	Click <b>Expand All</b> .
Collapse the Features tree	Click <b>Collapse All</b> . All the feature type nodes are collapsed.

## Related Topics

[Features Histogram Dialog Box](#)

# Chapter 3

## General Reference

---

The following topics provide general reference information for working with the ODB++Design interfaces.

- [Shortcuts to Graphic Area Functions](#)
- [Layer Parameters](#)
- [Layer Subtypes](#)
- [Layer Attributes](#)

# Shortcuts to Graphic Area Functions

You can use keyboard shortcuts and mouse clicks to navigate and control the graphic area.

- [Mouse Button Codes](#)
- [Graphic Area Shortcuts](#)
- [Control Dialog Box Shortcuts](#)
- [Zoom and Display Shortcuts](#)
- [Feature and Component Selection Actions](#)
- [Snap Hot Keys](#)
- [Matrix Shortcuts](#)

## Mouse Button Codes

The mouse button codes used in the user interface.

**Table 1. Mouse Button Codes**

Mouse Button Code	Description
M1	Single click the left mouse button.
M2	Single click the center mouse button on a 3-button mouse.
M3	Single click the right mouse button.
M1M1	Double-click the left mouse button.
M2M2	Double click the center button on a 3-button mouse. On a 2-button mouse under Windows, double-click both buttons simultaneously.
M3M3	Double click the right mouse button.
M1 M1	Two separated clicks of the left mouse button

## Graphic Area Shortcuts

These keys and mouse buttons are associated with graphic area functions.

**Table 2. Graphic Area Shortcuts**

Key or Mouse Button	Function
double-click	Graphic execute.



**Table 2. Graphic Area Shortcuts (continued)**

Key or Mouse Button	Function
Enter	Graphic execute.
E	Graphic execute.
N	Selects the next feature (single edit operations and single select).
click	Selects.
click or drag the middle button	<ul style="list-style-type: none"> <li>• Terminates the rubberband display.</li> <li>• If a selection tool is active:               <ul style="list-style-type: none"> <li>• Middle-click — Deselects a feature.</li> <li>• Middle-click — Cancels a rectangle you have started to draw.</li> <li>• Middle-click — Cancels the last side you have drawn in a selection polygon.</li> <li>• Shift-middle-click — Deselects all features.</li> <li>• Middle-double-click on a selected feature — Deselects all features with the same symbol.</li> </ul> </li> <li>• In the Copper/Exposed Measurement dialog box: Cancels rectangle-selection mode.</li> <li>• Pans in the graphic area if no selection tool or area zoom tool is active, and you are not in the Copper/Exposed Measurement dialog box:               <ul style="list-style-type: none"> <li>• Center in Graphic Area — Middle-click a point in the graphic area. The click point is panned to the center of the graphic area.</li> <li>• Zoom Out — With the middle button, drag a diagonal up and to the right, ending at the point you want in the center of the graphic area.</li> <li>• Zoom In — With the middle button, drag a diagonal down and to the left, ending at the point you want in the center of the graphic area.</li> <li>• Zoom to Area — With the middle button, drag a diagonal down and to the right, so that the start and end of the line you drag define a rectangular area to which you want to zoom.</li> <li>• Zoom Home — With the middle button, drag a diagonal up and to the left. The board is centered in the graphic area.</li> </ul> </li> </ul>
right-click	Opens a menu relevant to the area being clicked.

## Control Dialog Box Shortcuts

These keys and mouse buttons can be used to perform graphic control functions.

**Table 3. Control Dialog Box Shortcuts**

Key	Function
Ctrl-W	Feature display width (outline)
Ctrl-N	Negative data display mode
Ctrl-M	Layer Display Mode
Alt-U	Units
Alt-Y	Layer Profile Display
Alt-Z	Layer Zone Display

## Related Topics

[Control Dialog Box](#)

# Zoom and Display Shortcuts

These are the keys and mouse buttons associated with Zoom and Display functions.

**Table 4. Zoom and Display Shortcuts**

Key or Mouse Button	Function
Ctrl-F	Refreshes the screen
F1	Opens online help
Home or Ctrl-H	Zooms home
Page Up or Ctrl-I	Zooms in
Page Down or Ctrl-O	Zooms out
Ctrl-A	Zooms selected area
double-click	Zooms in and centers feature (zoom area icon selected)
Ctrl-double-click	Zooms out and centers feature (zoom area tool selected)
Shift-double-click	Zooms in double size and centers (zoom area tool selected)
Ctrl-Home	Zooms to selected feature
Shift-Home	Zooms to highlighted feature
Ctrl-Space	Copies the current zoomed display to memory
Ctrl-Shift- Space	Returns to the zoomed display in memory after zooming other areas

**Table 4. Zoom and Display Shortcuts (continued)**

Key or Mouse Button	Function
Ctrl-E	Pans to mouse pointer position and centers
Right Arrow or Ctrl-R	Pans right
Ctrl-Shift-R	Pans right with 90% overlap
Left Arrow or Ctrl-L	Pans left
Ctrl-Shift-L	Pans left with 90% overlap
Up Arrow or Ctrl-U	Pans up
Ctrl-Shift-U	Pans up with 90% overlap
Down Arrow or Ctrl-D	Pans down
Ctrl-Shift-D	Pans down with 90% overlap

## Related Topics

[Zooming and Panning](#)

[Graphic Area Shortcuts](#)

# Feature and Component Selection Actions

Selection can be performed on a single feature or component, by drawing a rectangle or polygon around a number of features or components, or by selecting a net and its features.

## Feature Selection Shortcuts

**Table 5. Feature Selection Shortcuts**

Key or Mouse Button	Function
click	Selects single feature.
click-N	Selects the next contiguous feature. Press N repeatedly until the feature you want is selected. Used to select a feature in a densely populated area.
double-click	Selects globally.
Shift-click	Selects additionally.
middle-click	Deselects single feature.

**Table 5. Feature Selection Shortcuts (continued)**

Key or Mouse Button	Function
E {Cursor-E}	<ul style="list-style-type: none"> <li>• With highlight tool selected, highlights the feature under the mouse pointer.</li> <li>• With zoom area tool selected, selects with the rubber band.</li> </ul>
Shift-middle-click	Deselects globally.

## Select by Rectangle Shortcuts

**Table 6. Select by Rectangle Shortcuts**

Key or Mouse Button	Function
click...click	Selects features inside a rectangle (drag to opposite corner).
Shift-click...click	Additionally selects features inside a rectangle (drag to opposite corner).
Ctrl-click...click	Selects inside and touching the polygon.
Shift-middle-click	Deselects globally.

## Selection by Polygon Shortcuts

**Table 7. Selection by Polygon Shortcuts**

Key or Mouse Button	Function
click...click	Selects features inside a polygon (drag to opposite corner).
Shift-click...click	Additionally selects features inside a polygon (drag to opposite corner).
Ctrl-click...click	Selects inside and touching the polygon.
Shift-middle-click	Deselects globally.

## Selection by Polygon Shortcuts

**Table 8. Selection by Net Shortcuts**

Key or Mouse Button	Function
click	Selects all features of the electrical net.
Shift-click	Selects all features of another electrical net.

**Table 8. Selection by Net Shortcuts (continued)**

Key or Mouse Button	Function
Shift-middle-click	Deselects globally.

## Snap Hot Keys

This table describes the shortcut keys associated with the Snap function:

**Table 9. Snap Shortcut Keys**

Keys/Mouse button	Function
SG	Snap grid
SC	Snap center
SE	Snap skeleton
SA	Snap advance
SI	Snap intersect
SM	Snap midpoint
SP	Snap profile
SO	Snap off
Ctrl+G	Grid on/off

### Related Topics

[Snap Dialog Box](#)

## Matrix Shortcuts

The Matrix window offers keyboard shortcuts and mouse click access in specific areas.

**Table 10. Matrix Actions Menu Shortcuts**

Keys	Function
Ctrl-F	Refreshes screen

**Table 11. Key Combinations and Mouse Options for Layer View Navigation**

Key	Ctrl Combination	Mouse Option	Function
Home	Ctrl-H		Zoom home — display full layer up to limits
PgUp	Ctrl-I	Press the scroll button and drag the mouse to the right and down.	Zoom in — enlarge view by 90%
PgDn	Ctrl-O	Press the scroll button and drag the mouse to the left and up.	Zoom out — reduce view by 90%
	Ctrl-A		Zoom area — click one corner then opposite corner of rectangle to display.
	Ctrl-E		Pan center of display to cursor position
right_arrow	Ctrl-R		Pan right with 90% overlap
Shift-right_arrow	Ctrl-Shift-R		Pan right with 10% overlap
left_arrow	Ctrl-L		Pan left with 90% overlap
Shift-left_arrow	Ctrl-Shift-L		Pan left with 10% overlap
up_arrow	Ctrl-U		Pan up with 90% overlap
Shift-up_arrow	Ctrl-Shift-U		Pan up with 10% overlap
down_arrow	Ctrl-D		Pan down with 90% overlap
Shift-down_arrow	Ctrl-Shift-D		Pan down with 10% overlap

## Related Topics

[Matrix Window](#)

# Layer Parameters

In the product model Matrix, the layer parameter columns represent the basic layer characteristics: name, type, subtype, context, polarity, reference, and dielectric reference.

## Layers

Name of the layer selected in the matrix.

## Type

The type assigned to a layer is indicated by the color of the layer row in the matrix:

- signal
- power\_ground
- mixed
- solder\_mask
- silk\_screen
- solder\_paste
- drill
- rout
- document
- mask
- dielectric
- conductive\_paste

## Subtype

Layer subtype from the list of subtypes available for the assigned layer type. See [“Layer Subtypes”](#) on page 41.

## Context

Controls whether the layer is part of the physical board:

- **board** — Layers that are part of the physical board.
- **misc** — Any other layers, such as documentation and drill. These virtual layers contain information about the board, but they do not correspond to physical layers on the board.

## Polarity

Positive or negative layer polarity.

In negative copper layers, features represent laminate instead of copper.

## Reference

(Applicable to layer types solder\_mask, solder\_paste, silk\_screen, mask, and conductive\_paste) The layer with type = signal, power\_ground, or mixed, to which the features of the given layer are applied.

## Dielectric Reference

The position of the copper layer to which the dielectric layer relates: none, above, below, both.

Reference layers for dielectric layers are always copper layers.

## Related Topics

[Matrix Window](#)



# Layer Subtypes

Some layer types have subtypes that support specific cases such as drill representation, flex and flex rigid manufacturing, or embedded resistors and capacitors.

## Standard Layer Subtypes

### Standard Layer Subtypes

Standard layer subtypes available in the product model Matrix for various layer types.

#### Subtypes to Support Dielectric Layers

These layer subtypes support the dielectric layers:

Layer Subtype	Base Layer Type	Description
CORE	DIELECTRIC	Material that is pre-pressed layers according to a pattern of copper foil - prepreg - copper foil.
PREPREG	DIELECTRIC	Material that is constructed with fiberglass impregnated with resin. The resin is pre-dried, but not hardened, and when heated, flows to adhere to neighboring material.

#### Subtypes to Support Backdrill and Dual Diameter Drill

These layer subtypes support the possible unique needs of drill representation in product models:

Layer Subtype	Base Layer Type	Description
BACKDRILL	DRILL	Represents a backdrill procedure where the plating within a hole is removed from the unused portion of the matrix using a drill hole slightly larger than the original. This removes the connection from one side of the PCB.
DUAL_DIAMETER	DRILL	Represents a condition prior to plating where a slightly larger hole is drilled part way through the matrix at the same location as an existing hole.

#### Subtypes to Support Flex/Rigid Flex Manufacturing

These layer subtypes support the unique needs of Flex/Rigid Flex product models:

Layer Subtype	Base Layer Type	Description
AREA	DOCUMENT	Area definition.

General Reference  
Standard Layer Subtypes

Layer Subtype	Base Layer Type	Description
BEND_AREA	MASK	For labeling areas on the PCB bent when the PCB is in use.
FLEX_AREA	MASK	Stores the geometries of the flex portions of the board.
RIGID_AREA	MASK	Stores the geometries of the rigid portions of the board.
CARBON_MASK	CONDUCTIVE_PASTE	Defines the location where carbon ink is applied to copper layers.
COVERCOAT	SOLDER_MASK	Clearances of a covercoat layer.
COVERLAY	SOLDER_MASK	Clearances of a coverlay layer.
DRAWING	DOCUMENT	Drawing layer definition
IMMERSION_MASK	MASK	Defines which features are to be covered during immersion in the gold process.
MIXED_FLEX	MIXED	Mixed copper layer—a layer containing both power/ground planes and regular signal pads or traces—on flex laminate. Used to distinguish from a Mixed copper layer on rigid laminate in a rigid-flex board.
OSP_MASK	MASK	Defines which features are to be covered with OSP finish.
PG_FLEX	POWER_GROUND	Power and ground (copper) layer on flex laminate. Used to distinguish from power and ground layer on rigid laminate in rigid-flex boards.
PLATING_MASK	MASK	Defines which features in the adjacent copper layer should be plated.
PSA	MASK	Shapes and locations where PSA (Pressure Sensitive Adhesive) material is placed on the PCB.
PUNCH	ROUT	Pattern to be punched by a die-cut fixture.
SIGNAL_FLEX	SIGNAL	Signal (copper) layer on flex laminate. Used to distinguish from signal on rigid laminate in rigid-flex boards.
SILVER_MASK	CONDUCTIVE_PASTE	Defines the silver mask of the adjacent copper layer.
STIFFENER	MASK	Shapes and locations where stiffener material is placed on the PCB.

## Subtypes to Support Embedded Resistors and Capacitors

These layer subtypes support the unique needs of product models containing embedded resistors and embedded capacitors:

Layer Subtype	Base Layer Type	Description
EMBEDDED_C	MASK	Feature shapes on the layer represent embedded capacitors.
EMBEDDED_R	MASK	Feature shapes on the layer represent embedded resistors.

### Related Topics

[Matrix Window](#)

## Layer Attributes

Layer attributes add intelligence to the step data. You can control the display of these columns in the Matrix window by selecting or clearing the respective check boxes in the Layer Attributes pane.

### Backdrill Max. Depth

The maximum allowable backdrill depth.

Values: 0.0 - 1000.0

Default: 0

### Backdrill not Penetrate Layer Name

Name of the layer not to be penetrated by the backdrill.

Values: <Free text (0 - 64 characters)>

### Bulk Resistivity

The ohmic resistance of the semiconductor material.

Values: 0.0 - 10000 nano\_ohm

### Characteristic Impedance

The typical characteristic impedance (in ohms) required for a layer.

Values: 0.0 - 10000.0 ohm

Default: 0 ohm

### Comment

Use for general textual comments.

Values: <Free text (0 - 500 characters)>

## Copper Thickness

The weight of copper according to its units of measure.

This layer attribute reflects the density of the copper used. Copper Thickness is measured in ounces per square feet.

Values: 0.0 - 1000.0

Default: 0

### Value Calculation

Copper Thickness is calculated as  $\langle layer\_thickness \rangle / \langle copper\_weight \rangle$ .

Where:

- **layer\_thickness** — The value defined in EDA data for each layer. Each format may define this value using a proprietary keyword or field.
- **copper\_weight** — The layer thickness value divided by the value of the configuration parameter copper\_weight (default value = 1.35). This value reflects the density of the copper used.

## Dielectric Constant (ER)

The ratio of the field without dielectric ( $E_0$ ) to the net field ( $E$ ) with dielectric. It is unitless and has a range value of 1 for metals. Typical values are 4 and 5.

## Dielectric Thickness

For layers of type DIELECTRIC or SOLDERMASK, contains the thickness of material. For layers of type SOLDER PASTE, contains the thickness of the metal mask (stencil). The value is in specified units of measure.

Values: 0.0 - 500 ml | 0.0 - 12700 mu

Default: 0

## Embedded Passive Technology

Assigns a technology type attribute to an embedded components layer.

Values: none | additive | subtractive

Default: none

## HDI Assembly Technology

Type of HDI assembly technology identified in the product model. If None, the special layer is not created.

Values: none | wirebond | flipchip | hybrid

Default: none

## HDI Layer Type

An attribute added to a copper layer, not a dielectric layer, to distinguish buildup layers from core layers in HDI product models.

Values: buildup | core

Default: buildup

### Value Assignment

The value depends on the dielectric layer Subtype and Dielectric Reference:

- If the dielectric layer Subtype = prepreg, the associated copper layers determined by Dielectric Reference are assigned HDI Layer Type = buildup.
- If the dielectric layer Subtype = Core, the associated copper layers determined by Dielectric Reference are assigned HDI Layer Type = core.

### Impedance test width

Test width of routes used for the provided impedance result.

Values: -2147483648.0 - 2147483648.0 ml

Default: 0 ml

### Loss Tangent

The parameter of a dielectric material that quantifies its inherent dissipation of electromagnetic energy.

Values: 0 - 100

Default: 0

### Related Topics

[Matrix Window](#)



# Chapter 4

## GUI Reference

---

This chapter describes the GUI elements that are common to all ODB++Design applications.

- Matrix Window
- Control Dialog Box
- Component Information Dialog Box
- Colors Dialog Box
- Feature Information Dialog Box
- Component Display Options Dialog Box
- Features Histogram Dialog Box
- Snap Dialog Box
- View Orientation Dialog Box



# Matrix Window

To access:

- From the Engineering Toolkit: Click the **matrix** icon in the entity pane.



If the product model has no steps, the Create Step dialog box opens. Type the name of the step and click **OK** or **Apply**.

- From Graphic Station, Panel Designer: Choose **View > Matrix** or click the **Open Job's matrix** tool () tool.
- From the Valor NPI dashboard: Click the **Matrix** tool () in the Layer Controls toolbar.
- From CAM Compare: Choose **Tools > Matrix** or click the **Matrix** tool () tool.
- From ODB++ Viewer: Click the **Matrix** tool () tool.

The Matrix is a representation of the product model in which the rows are the product model layers (sheets on which elements are drawn for plotting, drilling and routing, or assembly). You can customize the Matrix window by moving the panes and toggling their display. The appearance settings are remembered for future Matrix sessions.



Figure 1. Matrix Window

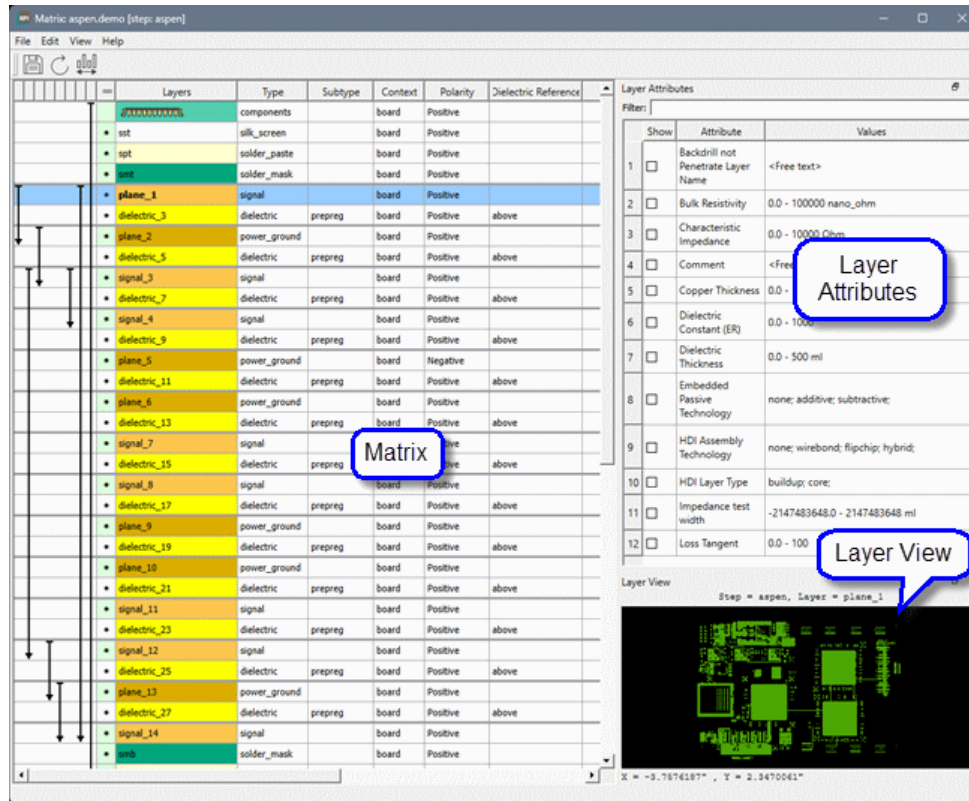



## Objects

Object	Description
Matrix rows	<p>Represent the layers in the product model step. The color reflects the layer type. The positioning of the layers reflects the layer stackup:</p> <ul style="list-style-type: none"> <li>• Top component, silk screen, solder paste, solder mask</li> <li>• Copper layers in their order</li> <li>• Solder mask, solder paste, silk screen, bottom component</li> <li>• Drill layers in sequence from where the drills started, to the largest depth (largest to smallest), then layer 2 to the largest depth, and so forth</li> <li>• Rout layers</li> <li>• Document and misc layers</li> </ul> <p>If HDI technology layers are present in EDA data, they are displayed above or below the relevant top or bottom component layers.</p> <p>The color of the drag handle cell to the left of the name is colored green if there are features on the layer.</p>

Object	Description
	<p>Layer contains no features → • dielectric_1</p> <p>Layer contains features → • signal_1</p>
Matrix columns	<p>Display the drill/rout spans and the values for the layer parameters and attributes.</p> <ul style="list-style-type: none"> <li>• <b>Drill or rout spans</b> — The left-most column represents the drill and rout spans, with the arrows indicating the drill direction. This column cannot be hidden.</li> </ul> <p>There is a span bar for each drill and rout layer. The span bars appear as solid lines, except for the layers with the subtype “backdrill” whose span bars appear as dotted lines.</p> <ul style="list-style-type: none"> <li>• <b>Layer Parameters</b> — The basic layer characteristics: Type, Subtype, Context, Polarity, Dielectric Reference, and Reference. See “<a href="#">Layer Parameters</a>” on page 38.</li> </ul> <p>Click a column header and drag to the desired location. The layer parameter columns cannot be hidden.</p> <ul style="list-style-type: none"> <li>• <b>Layer Attributes</b> — The layer properties that add intelligence to the product model data. Only the attributes selected in the Layer Attributes pane are displayed.</li> </ul> <p>Click a column header and drag to the desired location.</p>
Layer Attributes ( <b>View &gt; Layer Attributes</b> )	<p>Lists the available layer attributes that you can display as the Matrix columns. See “<a href="#">Layer Attributes</a>” on page 43.</p> <p>Select or clear the check box in the Show column to include or exclude the layer attribute column from the Matrix.</p> <p>Type a string in the Filter field to display only the attributes containing that string in the Attribute or Values field.</p>
Layer View ( <b>View &gt; Layer View</b> )	<p>Displays a thumbnail graphic of the layer selected in the Matrix. See <a href="#">Table 11: Key Combinations and Mouse Options for Layer View Navigation</a> for the key combinations and mouse options for navigating and controlling the display.</p>

## Usage Notes

- Choose **File > Step** and select the step to be displayed.
- If editing is enabled, choose **File > Save** or click  to save the product model, including the modifications you have made in the Matrix.
- Choose **Edit > Toggle Units** or click  to switch between metric and imperial units.
- Choose **View > Refresh** or click  to refresh the screen display.

# Control Dialog Box

To access:

- From Graphic Station, Panel Designer: **Options > Graphic Control**.
- From Valor NPI dashboard, DFMA Result Viewer: **Tools > Options > Graphic Options**.
- From CAM Compare, ODB++ Viewer: **View > Control**.
- Right-drag down and to the right in the graphic area ().

Use this dialog box to control the display of data in the graphic area.

Figure 2. Control Dialog Box



## Fields

Field	Description
Width	Controls how features are depicted in the graphic area.

Field	Description
	<ul style="list-style-type: none"> <li>• <b>On</b> — Displays filled features</li> <li>• <b>Outline</b> — Displays outlines of features</li> <li>• <b>Off</b> — Displays skeletons of features</li> </ul> <p>Skeleton is the same as outline for all features except lines and arcs, where the skeleton is a hairline through their centers from their start point to their end point.</p> <p>Ctrl-w toggles among the options.</p>
Negative Data	<p>Controls how negative data and positive data is displayed in the graphic area.</p> <ul style="list-style-type: none"> <li>• <b>Show Clear</b> — Negative data erases positive data.</li> <li>• <b>Show Dim</b> — Negative data is displayed as dimmed.</li> </ul> <p>Ctrl-n toggles between the options.</p>
Layer Display Mode	<p>Controls whether layers are displayed in transparent mode or in opaque mode in the graphic area.</p> <ul style="list-style-type: none"> <li>• <b>Transparent</b> — Layers are transparent.</li> <li>• <b>Opaque</b> — Layers are opaque. The color of a recently opened layer overrides underlying colors.</li> </ul> <p>Mixing of overlapping transparent layer colors depends on the operating system.</p> <p><b>Windows</b> — Color mixing is non-realistic.</p> <p><b>UNIX</b> — Color mixing depends on the color representation. For True Color, color mixing is non-realistic. For 8-bit, color mixing is realistic.</p> <p>Ctrl-m toggles between the options.</p>
Step & Repeat Features Display	<p>Controls the display when panelization has been performed on a product model.</p> <ul style="list-style-type: none"> <li>• <b>Yes</b> — Displays the panel and all features of selected layers in their Step &amp; Repeat sequences.</li> <li>• <b>No</b> — Displays only Step &amp; Repeat outlines used in panelization.</li> </ul>
Drill/Rout Data Display	<p>Controls how drill and rout data is displayed.</p> <ul style="list-style-type: none"> <li>• <b>Regular</b> — Shows pads in drill layers</li> <li>• <b>Markers</b> — Shows markers, instead of pads, indicating tool number (Excellon files)</li> </ul> <p>Marker symbols are customizable.</p>
Dynamic Texts Display	<p>Controls how dynamic text is displayed.</p> <ul style="list-style-type: none"> <li>• <b>Value</b> — Shows translated value of embedded code. Dynamic texts can be accessed when adding text features</li> <li>• <b>Name</b> — Shows code label only without its translated value</li> </ul>
Units	<p>Controls the units of measurement in which distance values are displayed.</p>

Field	Description
	<ul style="list-style-type: none"> <li>• <b>Inch/mils</b> — Displays distances in inches or mils</li> <li>• <b>mm/microns</b> — Displays distances in millimeters or microns</li> </ul> <p>Alt-u toggles between the options.</p>
Popview Continuous Mode	<p>Controls how the magnified view in the Popview window is refreshed.</p> <ul style="list-style-type: none"> <li>• <b>Off</b> — Only when the user stops panning</li> <li>• <b>On</b> — Continuously</li> </ul>
Features Histogram Auto Update	<p>Controls how the features histogram is updated.</p> <ul style="list-style-type: none"> <li>• <b>Yes</b> — Provides continuous update of the Features Histogram when features are added or removed</li> <li>• <b>No</b> — Updates the histogram when you click <b>Update</b></li> </ul>
Slots Histogram Auto Update	<p>Controls how the slots histogram is updated.</p> <ul style="list-style-type: none"> <li>• <b>Yes</b> — Provides continuous update of the Slots Histogram when slots are added or removed</li> <li>• <b>No</b> — Updates the histogram when you click <b>Update</b></li> </ul>
Graphic Cursor	<p>Controls how the mouse pointer is indicated in the graphic area.</p> <ul style="list-style-type: none"> <li>• <b>Regular</b> — As a plus sign (+)</li> <li>• <b>Full Screen</b> — As cross hairs spanning the graphic area</li> </ul>
Profile Display	<p>Controls the profile display.</p> <ul style="list-style-type: none"> <li>• <b>Yes</b> — Displays profile</li> <li>• <b>No</b> — Does not display profile</li> </ul>
Dimension Display	<p>Controls the display of distance indicators on lines in the Rout Profile Editor.</p> <ul style="list-style-type: none"> <li>• <b>Yes</b> — Display distance indicators</li> <li>• <b>No</b> — Do not show dimension indicators</li> </ul>
Chain Display	<p>Controls the display of chain layer features in the Rout Profile Editor.</p> <ul style="list-style-type: none"> <li>• <b>Yes</b> — Display chain layer features.</li> <li>• <b>No</b> — Do not display chain layer features.</li> </ul>
Compensated Display	<p>Controls the display of the compensated rout layer in the Rout Profile Editor.</p> <ul style="list-style-type: none"> <li>• <b>Yes</b> — Display the layer.</li> <li>• <b>No</b> — Do not display the layer.</li> </ul>
Dimension Msg Display	<p>Controls the display of Rout Profile Editor messages reporting invalid dimension links, when source or destination elements are modified.</p> <ul style="list-style-type: none"> <li>• <b>Yes</b> — Display the messages.</li> <li>• <b>No</b> — Do not display the messages.</li> </ul>

Field	Description
FS & SMT Direction Display	<p>Controls whether arrows are superimposed in the Overview pane to indicate top and bottom Flow Solder and SMT direction as set in the entity attributes of the step.</p> <ul style="list-style-type: none"> <li>• <b>Yes</b> — Display the arrows.</li> <li>• <b>No</b> — Do not display the arrows.</li> </ul> <p>The direction of the arrows viewed from the top layer toward the bottom layer is determined by the step attributes. These are the directions:</p> <ul style="list-style-type: none"> <li>• left2right</li> <li>• right2left</li> <li>• top2bottom (vertical direction from the top edge to bottom edge of a board)</li> <li>• bottom2top (vertical direction from the bottom edge to top edge of a board)</li> </ul> <p>These are the step attributes:</p> <ul style="list-style-type: none"> <li>• SMT Direction (Bottom)</li> <li>• SMT Direction (Top)</li> <li>• Flow Solder Direction (Bottom)</li> <li>• Flow Solder Direction (Top)</li> </ul> <p>If the board is flipped or rotated, the display of arrows changes with the board.</p> <p>The default for this parameter is set in configuration parameter <code>edt_disp_fs_smt_direction</code>.</p>
Layer Profile Display	<p>Controls how the layer profile is indicated in the graphic area.</p> <ul style="list-style-type: none"> <li>• <b>Yes</b> — The layer profile is displayed as a grid of dots.</li> <li>• <b>Outline</b> — The outline of the layer profile is indicated by a dotted line.</li> <li>• <b>No</b> — The layer profile is not indicated (default)</li> </ul> <p>Alt-y toggles among the options.</p>
Layer Zone Display	<p>Controls how layer zones are indicated in the graphic area.</p> <ul style="list-style-type: none"> <li>• <b>Yes</b> — Layer zones are displayed. The areas are labeled. Rigid zones are a solid color and flex zones are displayed in a pattern.</li> <li>• <b>Outline</b> — The outline of layer zones is indicated by a solid line.</li> <li>• <b>No</b> — Layer zones are not indicated. (default)</li> </ul> <p>Alt-z toggles among the options.</p>

## Related Topics

[Configuring the Display](#)

[Control Dialog Box Shortcuts](#)

## Component Information Dialog Box

To access: Select or highlight a component in the graphic area and then perform the action appropriate for your interface:

- From Valor NPI dashboard, choose **Edit > Feature Info**.
- From Valor NPI dashboard, DFM Result Viewer, Graphic Station, Panel Designer, click the data bar.
- From any interface, click the info button () in the toolbar.

You can use the Component Information dialog box to view information about the component selected or highlighted in the graphic area. The dialog box consists of the following panes: Identification, DESCRIPTION, ATTRIBUTES, and PROPERTIES.



Figure 3. Component Information Dialog Box

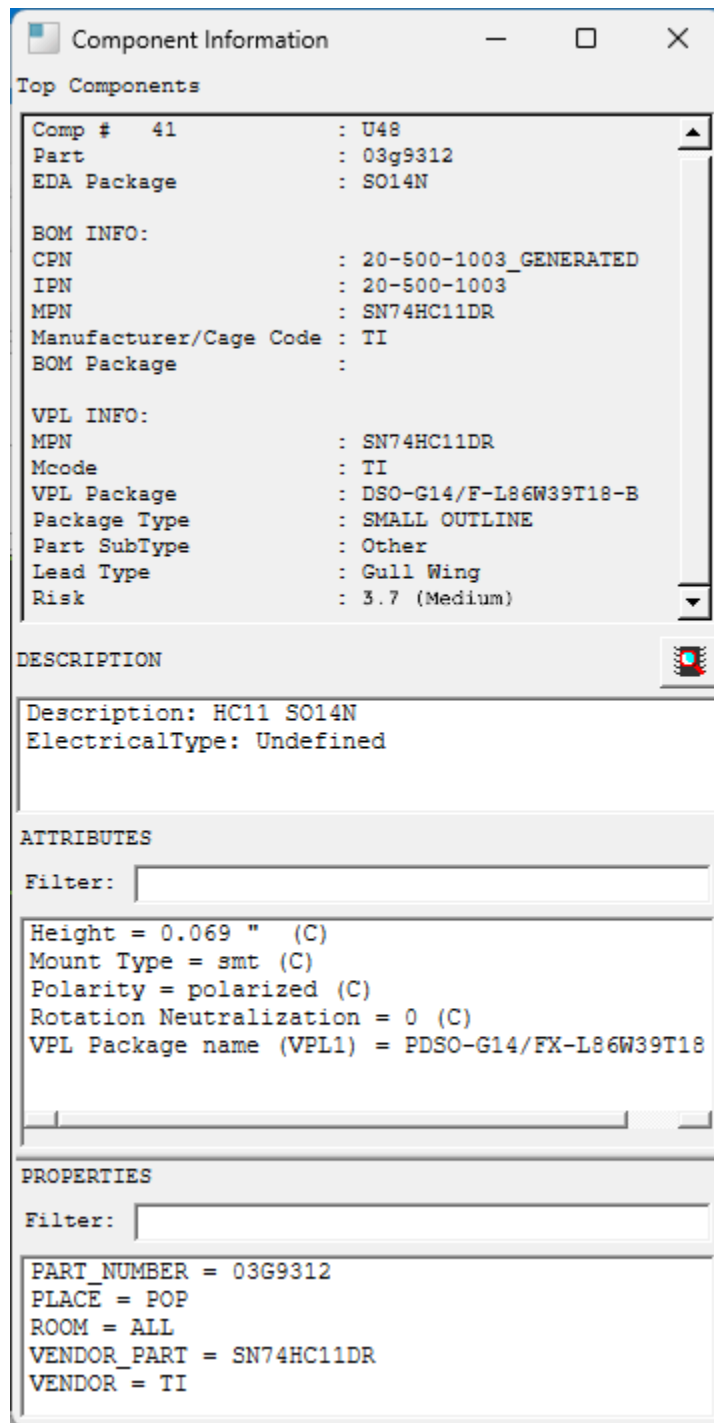

## Objects

Object	Description
Identification	<p>Lists the component identifiers derived from various sources.</p> <ul style="list-style-type: none"> <li>• Information in the CAD data: <ul style="list-style-type: none"> <li>• <b>Layer</b> — The layer in which the component resides.</li> <li>• <b>Index</b> — The index number of the component.</li> <li>• <b>RefDes</b> — The reference designator of the component.</li> <li>• <b>Part</b> — The part number of the component.</li> <li>• <b>EDA Package</b> — The name of the package.</li> </ul> </li> <li>• BOM INFO: <ul style="list-style-type: none"> <li>• <b>CPN</b> — The customer part number of the component.</li> <li>• <b>IPN</b> — The internal part number of the component.</li> <li>• <b>Manufacturer</b> — The manufacturer of the component.</li> <li>• <b>BOM Package</b> — The name of the package.</li> </ul> </li> <li>• VPL INFO: <ul style="list-style-type: none"> <li>• <b>MPN</b> — The manufacturer's part number of the matched part.</li> <li>• <b>Mcode</b> — The name representing all variations of the manufacturer's name for the matched part.</li> <li>• <b>VPL Package</b> — The name of the matched package in the VPL.</li> <li>• <b>Package Type</b> — The type of the matched part's package.</li> <li>• <b>Part SubType</b> — The subtype of the matched part.</li> <li>• <b>Lead Type</b> — The type of the matched part's leads.</li> <li>• <b>Risk</b> — The likelihood of creating a poorly soldered joint or the entire component requiring rework. The value is the sum of the risk scores of the various package geometry aspects (Position Type, Package Type, Lead Form, Number of Leads, Pitch [for Package Type = GA], and Package Size): <ul style="list-style-type: none"> <li>- Low (less than or equal to two)</li> <li>- Medium (between two and four)</li> <li>- High (greater than four)</li> </ul> </li> </ul> </li> </ul>
View image/Datasheet	(If available) Displays in a browser the component's image and/or datasheet on the manufacturer's web site.
DESCRIPTION	Lists the values in the description fields in the BOM: desc1...10.
ATTRIBUTES	<p>Lists the attributes with Entity = "Component" or "Package" that have been assigned manually, at CAD input, or during analysis.</p> <p>In the Filter field, type a string to display only the attributes containing this string in their name.</p>

Object	Description
PROPERTIES	Lists the properties in the Component and Package groups that have been assigned at CAD input or during analysis.  In the Filter field, type a string to display only the properties containing this string in their name.

## Related Topics

[Viewing Component and Feature Information](#)

# Colors Dialog Box

To access:

- From Valor NPI dashboard: **Tools > Options > Color Options**
- From Graphic Station, Panel Designer: **Options > Colors**
- From other viewers: **View > Color Settings**

Use this dialog box to set colors for displaying entities in the graphic area: layers, the background, features and components when you highlight or select them, and rubberband.

Figure 4. Colors Dialog Box

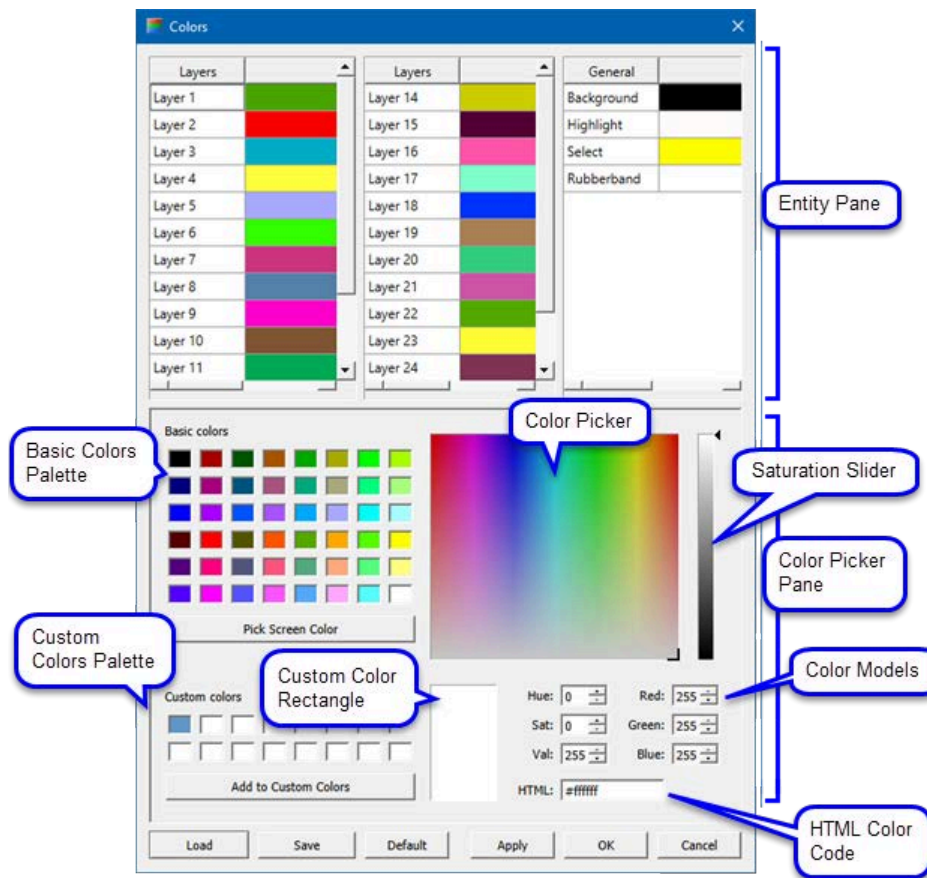



## Description

The Color Picker pane displays the color for the entity selected in the Entity pane.

## Objects

**Table 12. Colors Dialog Box - Entity Pane**

Field	Description
Layers	Displays the color of features and components that reside in the layers displayed in the graphic area. The layers are listed in the order of display (Layer 1 - Layer 25). Click a layer to select it.
General	<p>Displays the color of the following entities:</p> <ul style="list-style-type: none"> <li>• <b>Background</b> — The background of the graphic area</li> <li>• <b>Highlight</b> — Features and components when you highlight them (  )</li> <li>• <b>Select</b> — Features and components when you select them (  )</li> <li>• <b>Rubberband</b> — The shape outline that dynamically tracks the mouse pointer movement when you move a feature or a component</li> </ul> <p>Click an entity to select it.</p>

**Table 13. Colors Dialog Box - Color Picker Pane**

Field	Description
Basic colors palette	Displays pre-defined common colors as boxes. Click a color box: the fields in the Color Picker pane are updated to reflect the change.
Custom colors palette	Displays previously saved user-defined colors as boxes. Click a color box: the fields in the Color Picker pane are updated to reflect the change.
Color picker	Displays an array of colors. Click inside the field: the cursor changes to crosshairs and the fields in the Color Picker pane are updated to reflect the change.
Saturation slider	Enables you to adjust the intensity of the selected color. Click and drag the slider up or down: the fields in the Color Picker pane are updated to reflect the change.
Custom color rectangle	Displays a preview of the current color.
Color models	Displays the HSL and RGB values for the current color.
HTML color code	Displays the hex value for the current color.

**Table 14. Colors Dialog Box - Action Buttons**

Button	Description
Pick Screen Color	Enables you to pick a color from any region of your screen. Click the button and then click the desired location: the cursor changes to crosshairs and the fields in the Color Picker pane are updated to reflect the selected color.

**Table 14. Colors Dialog Box - Action Buttons (continued)**

Button	Description
Add to Custom Colors	Saves the current color to the Custom colors palette.
Load	Loads a previously saved color scheme.
Save	Saves the current color settings in a user-defined color scheme file at the user, design center, or system level, or at any location on the file system. The default name for a color scheme file is <i>colors</i> .
Default	Reverts to the system default colors.
Apply	Applies the current color to the selected entity. The color scheme remains throughout the session.
OK	Closes the dialog box and applies the color settings.
Cancel	Closes the dialog box without changing the colors.

## Related Topics

[Configuring the Display](#)

# Feature Information Dialog Box

To access: Select or highlight a feature in the graphic area and then perform the action appropriate for your interface:

- From Valor NPI dashboard, choose **Edit > Feature Info**.
- From Valor NPI dashboard, DFM Result Viewer, Graphic Station, Panel Designer, click the data bar.
- From any interface, click the info button (  ) in the toolbar.

You can use the Feature Information dialog box to view information about the feature selected or highlighted in the graphic area. The dialog box consists of the following panes: Geometry, Attributes, and Net Properties.

## Description

**Figure 5. Feature Information Dialog Box - Pad**

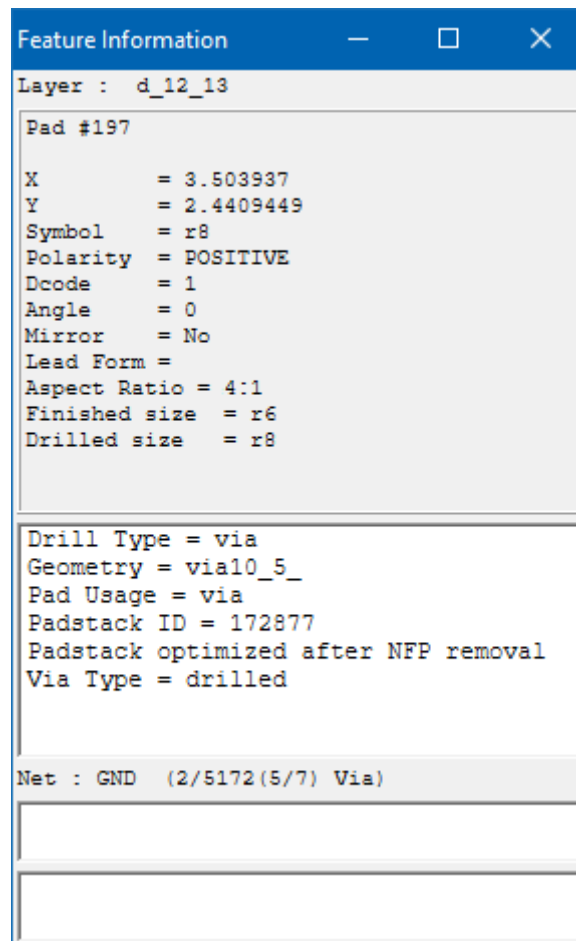

**Figure 6. Feature Information Dialog Box - Line**

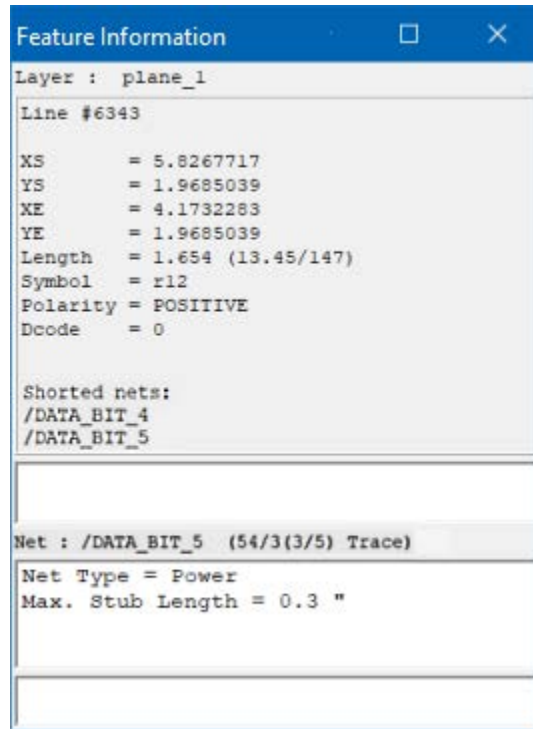



Figure 7. Feature Information Dialog Box - Arc

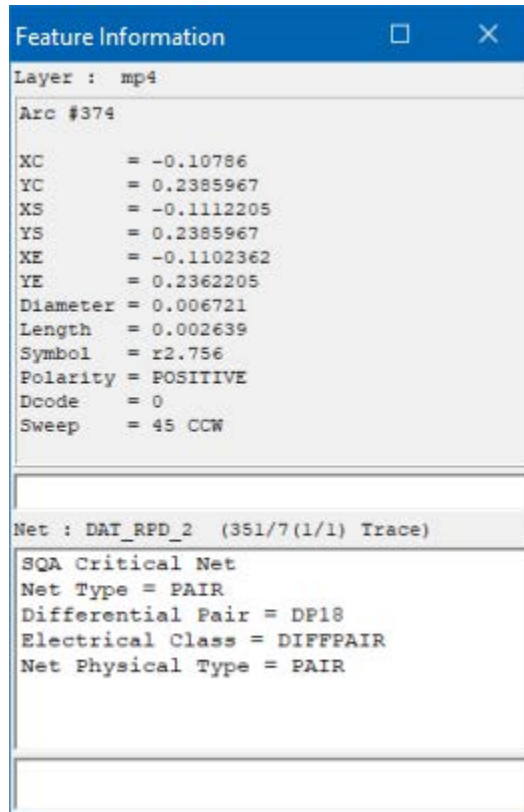
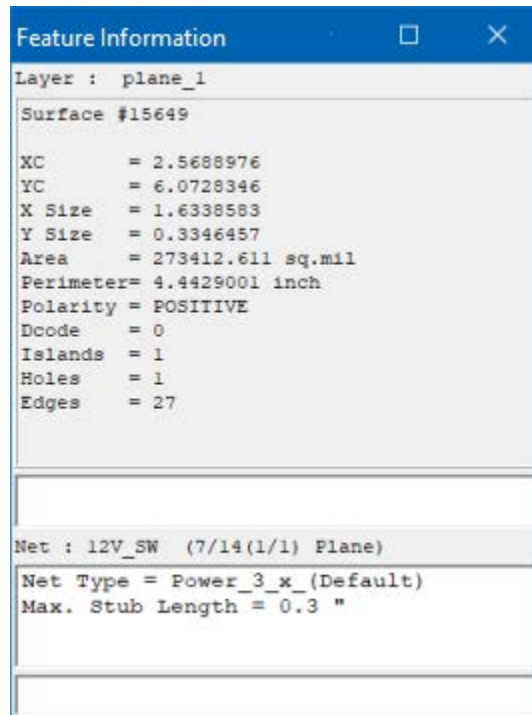

Figure 8. Feature Information Dialog Box - Surface



## Objects

**Table 15. Feature Information - Pad**

Object	Description
Geometry (Pad)	<p>Provides detailed information about the pad geometry.            See <a href="#">Figure 5: Feature Information Dialog Box - Pad</a>.</p> <ul style="list-style-type: none"> <li>• <b>Layer</b> — The layer in which the pad resides.</li> <li>• <b>Index</b> — The index number of the pad.</li> <li>• <b>X, Y</b> — The coordinates of the pad.</li> <li>• <b>Symbol</b> — The symbol used to create the pad.</li> <li>• <b>Polarity</b> — The polarity of the pad.</li> <li>• <b>Dcode</b> — The Dcode of the pad.</li> <li>• <b>Angle</b> — The angle of rotation of the pad.</li> <li>• <b>Mirror</b> — The mirroring of the pad.</li> <li>• <b>Lead Form</b> — The form of the lead associated with the pad.</li> <li>• <b>Aspect Ratio</b> — The ratio of the drill depth to its diameter. Displayed only for round drill pads that have a non-zero radius and whose span (cumulative thickness of the pierced copper and dielectric layers) is greater than zero.</li> <li>• <b>Finished size</b> — The size of the hole after plating, as determined by the Drill Tool Manager (DTM) status:               <ul style="list-style-type: none"> <li>• DTM applied — The Finish Size in the drill tool table.</li> <li>• DTM not applied — The symbol value.</li> </ul> </li> <li>• <b>Drilled size</b> — The size of the tool used to create the hole, as determined by the Drill Tool Manager (DTM) status:               <ul style="list-style-type: none"> <li>• DTM applied — The Drill Size in the drill tool table.</li> <li>• DTM not applied — No value is displayed.</li> </ul> </li> </ul>
Geometry (Line)	<p>Provides detailed information about the line geometry.            See <a href="#">Figure 6: Feature Information Dialog Box - Line</a> on page 64.</p> <ul style="list-style-type: none"> <li>• <b>Layer</b> — The layer in which the line resides</li> <li>• <b>Index</b> — The index number of the line</li> <li>• <b>XS, YS</b> — The coordinates of the line start</li> <li>• <b>XE, YE</b> — The coordinates of the line end</li> <li>• <b>Length</b> — The length of the line</li> <li>• <b>Symbol</b> — The symbol used to create the line</li> <li>• <b>Polarity</b> — The polarity of the line</li> <li>• <b>Dcode</b> — The Dcode of the line</li> </ul>

**Table 15. Feature Information - Pad (continued)**

Object	Description
Geometry (Arc)	<p>Provides detailed information about the arc geometry. See <a href="#">Figure 7: Feature Information Dialog Box - Arc</a> on page 65.</p> <ul style="list-style-type: none"> <li>• <b>Layer</b> — The layer in which the arc resides</li> <li>• <b>Index</b> — The index number of the arc</li> <li>• <b>XC, YC</b> — The coordinates of the arc center</li> <li>• <b>XS, YS</b> — The coordinates of the arc start</li> <li>• <b>XE, YE</b> — The coordinates of the arc end</li> <li>• <b>Diameter</b> — The arc diameter</li> <li>• <b>Length</b> — The arc length</li> <li>• <b>Symbol</b> — The symbol used to create the arc</li> <li>• <b>Polarity</b> — The polarity of the arc</li> <li>• <b>Dcode</b> — The Dcode of the arc</li> <li>• <b>Sweep</b> — The sweep angle the arc</li> </ul>
Geometry (Surface)	<p>Provides detailed information about the surface geometry. See <a href="#">Figure 8: Feature Information Dialog Box - Surface</a> on page 65.</p> <ul style="list-style-type: none"> <li>• <b>Layer</b> — The layer in which the surface resides</li> <li>• <b>Index</b> — The index number of the surface</li> <li>• <b>XC, YC</b> — The coordinates of the surface</li> <li>• <b>X Size, Y Size</b> — The size of the surface in the X and Y directions</li> <li>• <b>Area</b> — The area of the surface</li> <li>• <b>Perimeter</b> — The total length of the surface contour</li> <li>• <b>Polarity</b> — The polarity of the surface</li> <li>• <b>Dcode</b> — The Dcode of the surface</li> <li>• <b>Islands</b> — The number of islands contained in the surface</li> <li>• <b>Holes</b> — The number of holes contained in the surface</li> <li>• <b>Edges</b> — The number of edges contained in the surface</li> </ul>
Shorted Nets	<p>Lists the names of the nets that are shorted together by the feature.</p> <p> <b>Note:</b> Shorted nets information is only displayed for features defined in the short definitions file as creating intentional net shorts within the product model.</p> <p>See <a href="#">Figure 6: Feature Information Dialog Box - Line</a> on page 64.</p>
Attributes	<p>Lists the attributes that have been assigned to the feature at CAD input or during analysis.</p>
Net	<p>Provides the net information for the feature.</p>

**Table 15. Feature Information - Pad (continued)**

Object	Description
	<ul style="list-style-type: none"><li>• In <a href="#">Figure 5: Feature Information Dialog Box - Pad</a> on page 63, the Net GND is found on net #1, which has 976 subnets. This selected feature is a via. It is the first of the two features on the net. (1/2).</li><li>• In <a href="#">Figure 6: Feature Information Dialog Box - Line</a> on page 64, the Net DATA_BIT_5 is found on net #54, which has three subnets. This selected feature is a trace. It is the third of the five features on the net. (3/5).</li><li>• In <a href="#">Figure 7: Feature Information Dialog Box - Arc</a> on page 65, the Net DAT_RPD_2 is found on net #351, which has seven subnets. This selected feature is a trace. It is the first and only feature on the net. (1/1).</li><li>• In <a href="#">Figure 8: Feature Information Dialog Box - Surface</a> on page 65, the Net 12V_SW is found on net #7, which has 14 subnets. This selected feature is a plane. It is the first and only feature on the net. (1/1).</li></ul>
Net Attributes	Lists the net attributes of the feature. Net attributes are always shown in inch, regardless of the units specified.

## Related Topics

[Viewing Component and Feature Information](#)

# Component Display Options Dialog Box

Access as appropriate for the tool you are using:

- **Options > Components**
- **View > Component Options**

You can use the Component Display Options dialog box to configure some aspects of how components are displayed in component layers.

**Figure 9. Component Display Options Dialog Box**

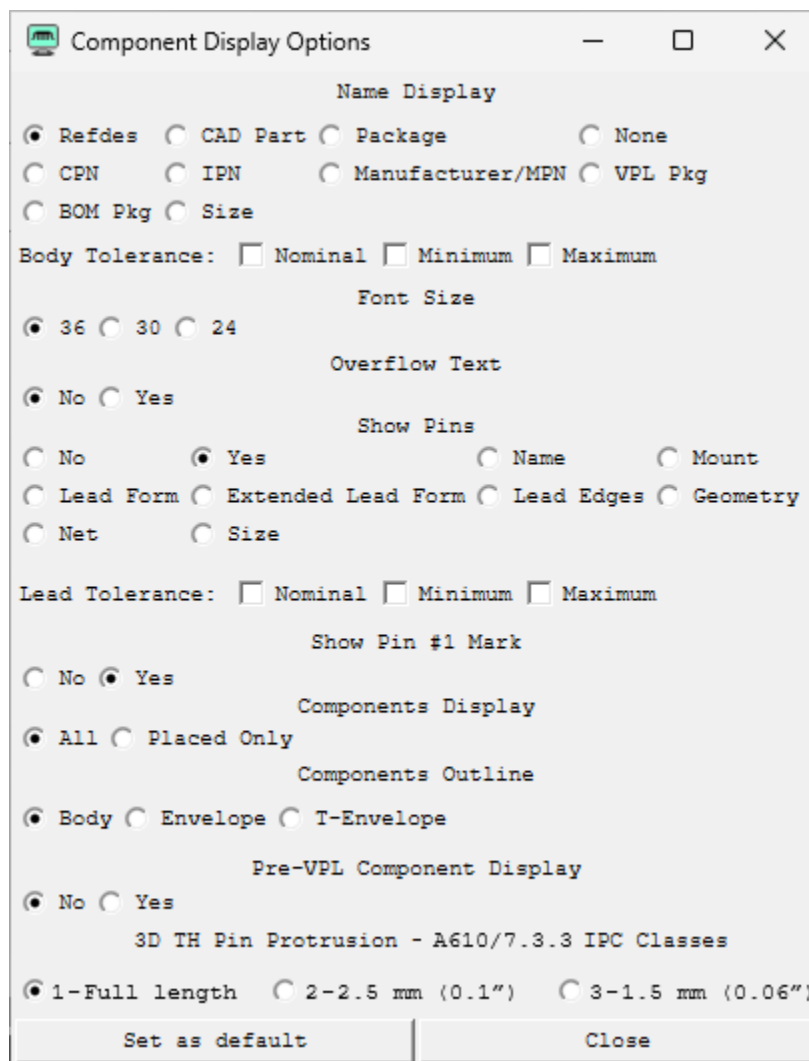

## Fields

Field/Button	Description
Name Display	<p>Defines the type of name or size to display for components.</p> <ul style="list-style-type: none"> <li>• <b>RefDes</b> — Reference designator.</li> </ul> <p>If the Placement Layer attribute is assigned, then its value appears next to the component name, according to the following convention:</p> <p><i>&lt;RefDes&gt;[&lt;placement layer&gt;]</i></p> <p>The placement layer indication is for display only and does not affect the component name.</p> <ul style="list-style-type: none"> <li>• <b>CAD Part</b> — The part number from CAD data.</li> <li>• <b>Package</b> — The package name from CAD data.</li> <li>• <b>None</b> — Do not display a name.</li> <li>• <b>CPN</b> — Customer Part Number from the BOM.</li> <li>• <b>IPN</b> — Internal Part Number.</li> <li>• <b>Manufacturer/MPN</b> — Manufacturer name and part number from the BOM.</li> <li>• <b>VPL Pkg</b> — Valor Parts Library package name.</li> <li>• <b>BOM Pkg</b> — Package name from the BOM.</li> <li>• <b>Size</b> — The X and Y dimensions of the package body. If the Minimum or Maximum body tolerances are also selected, then the display includes the difference between the nominal size and the minimum or maximum size.</li> </ul>
Body Tolerance	<p>Draws a dotted outline around the body of a VPL package to represent the Nominal, Minimum, and Maximum dimensions as defined in the VPL.</p> <p>The body nominal shape is the same as the component shape, unless the VPL packages are consolidated with the alternate ones (CPN mode), or the maximum body tolerance was selected for the merge.</p>
Font Size	Defines the font size for the component and pin names.
Overflow Text	Controls whether to allow text to extend beyond the component and pin outline.
Show Pins	<p>Controls whether to display leads, and if displayed, the type of information to show.</p> <ul style="list-style-type: none"> <li>• <b>No</b> — Components are displayed without leads.</li> <li>• <b>Yes</b> — Components are displayed with leads.</li> <li>• <b>Name</b> — Lead name is displayed on the leads.</li> <li>• <b>Mount</b> — The mount type is displayed on the lead as follows:</li> </ul> <p>If defined in the VPL or EDA data, the value is one of these:</p>

Field/Button	Description
	<ul style="list-style-type: none"> <li>• SMT</li> <li>• SMT_RP (“Recommended Pad”: Lead size is determined by the recommended exposed pad size and not by the lead geometry.)</li> <li>• TH</li> <li>• TH_RH (“Recommended Hole”: Lead size is determined by the recommended plated hole size and not by the lead geometry.)</li> <li>• PRESS_FIT</li> <li>• HOLE (Physical hole that might miss physical terminal; can be screw type.)</li> <li>• NON_BOARD (The lead is in the air.)</li> </ul> <p>If not defined, an alternate value of th, blind, sm, or osm can be displayed if set during EDA translation.</p> <p>M or EM is shown if the lead is mechanical or electromechanical.</p> <ul style="list-style-type: none"> <li>• <b>Lead Form</b> — If VPL data exists, the shape is indicated on the leads: A-Post Terminal, B-Butt or Ball, C-C-Bend, D-Lug, F-Flat Lead, G-Gull-Wing, J-J-Lead, L-L-Bend, M-Column, N-Surface Lead, O-Pressfit, P-Pin or Peg, Q-Quick Connect, R-Wraparound, S-S-Bend, T-Through Hole, U-Bend, W-Wire, X-Other, Y-Screw.</li> <li>• <b>Extended Lead Form</b> — If the VPL data contains the extended lead form, the following information is displayed: <ul style="list-style-type: none"> <li>• On the leads: &lt;Lead Form&gt; / &lt;Extended Lead Form&gt;</li> <li>• On the component sides: Classification used by analysis: leaded, unleaded, onedge (treated as leaded), or pullback (treated as unleaded)</li> </ul> </li> <li>• <b>Lead Edges</b> — If the VPL data contains the extended lead form, the lead edges are marked as (s)ide, (t)oe, or (h)eel.</li> </ul> <p> <b>Note:</b> Toe/heel determination is missing for VPL components with no extended lead form data. In this case, the lead edges are marked as (s)ide or (a)mbiguous.</p> <ul style="list-style-type: none"> <li>• <b>Geometry</b> — Leads are marked by their geometry (padstack name).</li> <li>• <b>Net</b> — Leads are displayed with their net names.</li> </ul>
Show Pins (Cont.)	<p>Controls whether to display leads, and if displayed, the type of information to show.</p> <ul style="list-style-type: none"> <li>• <b>Size</b> — The X and Y dimensions of the lead shape. If the Minimum or Maximum lead tolerances are also selected, then the display includes the difference between the nominal size and the minimum or maximum size.</li> </ul>
Lead Tolerance	<p>Draws a dotted outline around the leads of a VPL package to represent the Nominal, Minimum, and Maximum dimensions as defined in the VPL.</p> <p>The pins nominal shape is the same as the pins shape unless the maximum pins tolerance was selected for the VPL merge.</p>
Show Pin #1 Mark	<p>Selected, displays the Pin1 mark.</p>

Field/Button	Description
Components Display	<p>Controls the display of components that have the .comp_ignore system attribute.</p> <ul style="list-style-type: none"> <li>• <b>All</b> — All components are displayed.</li> <li>• <b>Placed Only</b> — Components with the .comp_ignore attribute are not displayed.</li> </ul> <p>This option affects several displays and functions in Valor NPI dashboard, Graphic Station, Engineering Toolkit, and Export.</p>
Component Outline	<p>Controls how the outline of the component body is displayed in the graphic area.</p> <ul style="list-style-type: none"> <li>• <b>Body</b> — As a solid line.</li> <li>• <b>Envelope</b> — As a solid line with pins outlined by a dotted line. The overall outline is the envelope.</li> <li>• <b>T-envelope</b> — As a solid line with toeprints in outer layer outlined by a dotted line. The overall outline is the T-envelope.</li> </ul>
Pre-VPL Component Display	<p>Controls the display of original component data (from CAD) before merging with VPL data, after VPL merge has been performed.</p> <ul style="list-style-type: none"> <li>• <b>No</b> — Displays only VPL data, if present.</li> <li>• <b>Yes</b> — Highlights component data before merging with VPL data, in addition to VPL data (displayed but not highlighted).</li> </ul> <p>If VPL merge has not been performed, both options display only pre-VPL data.</p>
3D TH Pin Protrusion - IPC A610/7.3.3 Classes	<p>Controls the length of TH lead protrusion in the 3D View based on IPC Class 1, 2, or 3:</p> <ul style="list-style-type: none"> <li>• <b>1 - Full length</b> — The lead is not cut and displays as defined in the VPL. (default)</li> <li>• <b>2 - 2.5 mm (0.1")</b> — The lead is cut 2.5 mm from the end of the board.</li> <li>• <b>3 - 1.5 mm (0.06")</b> — The lead is cut 1.5 mm from the end of the board.</li> </ul>

## Related Topics

[Configuring the Display](#)



# Features Histogram Dialog Box

To access:

- From the Layer List, right-click a layer name in the Layer List and choose **Features Histogram**.
- From the Features Search/Features Filter window (Editor configuration), click the **Select** button, and then click the **Histogram** button.

You can use the Features Histogram dialog box to select, highlight, or search for features residing in a layer of type Standard, Drill, or Rout.

**Figure 10. Features Histogram Dialog Box**

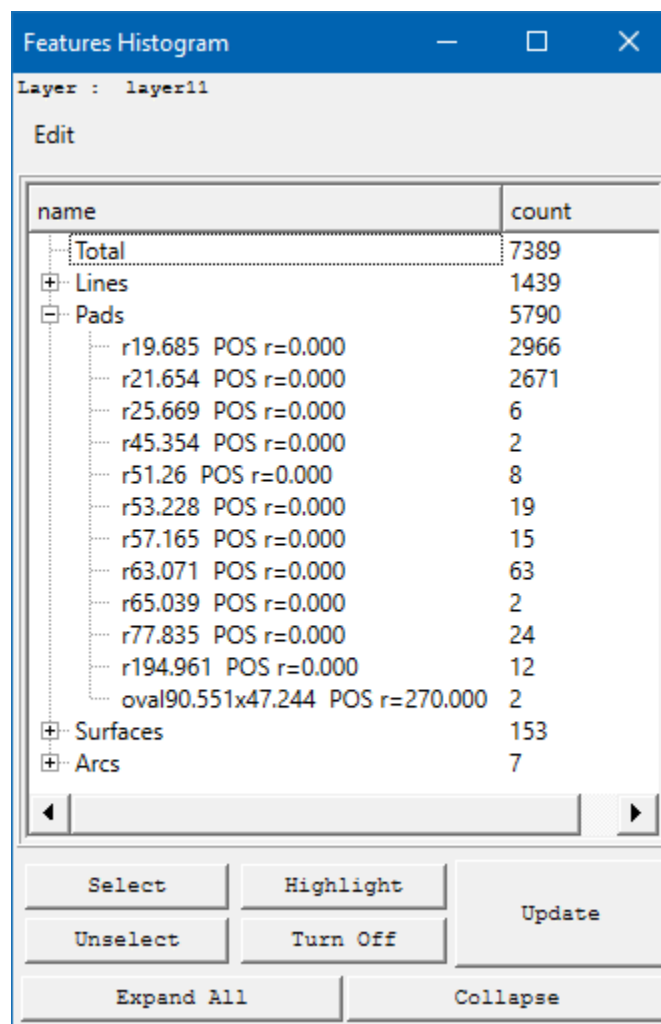

## Description

The behavior of the Features Histogram dialog box differs depending on how you invoke it:

- When invoked from the **Features Histogram** popup menu item, the dialog box displays all features residing in the specified layer.
- When invoked from the **Histogram** button in the Features Search or Features Filter dialog box, the dialog box displays only the selected features that match the filter criteria specified.



**Tip**

You can activate continuous update mode by setting the Features Histogram Auto Update option to Yes. See “Control Dialog Box” on page 51.



**Note:**

If you do not use feature selection tools, filters apply to all features in the Affected layers.

## Objects

**Table 16. Features Histogram Dialog Box**

Object	Description
Feature tree	The features of the layer appear as tree nodes, grouped by type (lines, pads, surfaces, and text). For each feature, the following information is displayed: <ul style="list-style-type: none"> <li>• Polarity</li> <li>• Resize</li> <li>• Degree of rotation</li> <li>• Count</li> </ul> Select one or more nodes and click one of the action buttons.
Select	Prerequisite: The selected layer is an Affected layer or Work layer. Cumulatively selects all features of the type selected in the Feature tree.
Unselect	Prerequisite: The selected layer is an Affected layer or Work layer. Unselects all features of the type to which the last selection action was applied.
Highlight	Highlights all features of the type selected in the Feature tree.
Turn Off	Removes highlighting from all features of the type to which the last highlight action was applied.
Update	Refreshes the histogram to reflect the specified layer and filter criteria (if applicable).
Expand All	Expands the Feature tree to all levels.
Collapse	Collapses the Feature tree.

## Related Topics

[Using the Features Histogram to Select or Highlight Features](#)

# Snap Dialog Box

To access:

- From Valor NPI dashboard, DFM Result Viewer: **Edit > Snap**
- From Graphic Station, Panel Designer: **Options > Snap**
- From any interface: **Control Snapping** tool ()

You can use the Snap dialog box to control whether the grid is displayed, and in what form. You can control how items snap to positions on the grid or to other items.

**Figure 11. Snap Dialog Box**

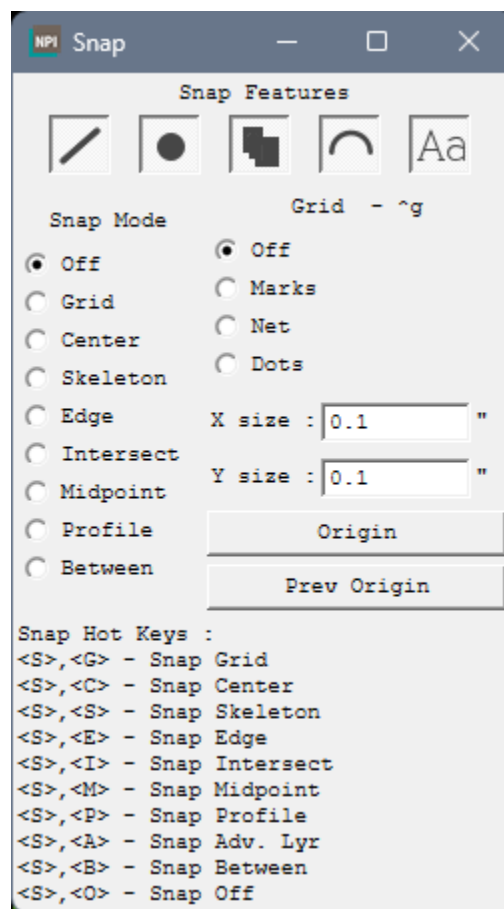

## Description

## Factors Affecting Snapping

Factor 1: Item Type

Snapping depends on the type of item selected, its snap point, and the distance to the nearest snap point.







**Table 17. Items to Which Snapping Applies**

Item	Snapping Location
Grid	At grid intersections.
Feature	<b>Line, Pad, Surface (area, polygon), Arc</b> — According to the current Snap mode as shown in <a href="#">Table 19: Feature Snap Points Per Snap Mode</a> . <b>Text</b> — To the beginning of the baseline: 
Reference layer in CAM Compare	A reference layer affected by the Move Layer action is highlighted with a rubber band. A click inside the rubber band sets the snap point to one of the following: <ul style="list-style-type: none"> <li>• The mouse cursor position (Snap mode = Off)</li> <li>• The closest board feature as shown in <a href="#">Table 19: Feature Snap Points Per Snap Mode</a> (Snap mode ≠ Off)</li> </ul>
Step in an assembly panel (if Panelization mode = Manual)	If Snap mode = Off, the selection of a step snaps to the nearest vertex on the board profile if clicked inside the step in proximity, otherwise, no snap is performed. If Snap mode ≠ Off, snapping is performed as follows: <ul style="list-style-type: none"> <li>• Clicking inside a step snaps according to the current Snap mode to the nearest board feature in the current Snap and Work layer.</li> <li>• Clicking outside of a step snaps to the panel features of the current Snap layer.</li> </ul>

### Factor 2: Snap Mode

The appearance of the **Control snapping** tool reflects the current snap mode.

**Table 18. Snap Modes**

Snap Mode	Appearance of the Tool	Shortcut	Snap Location
Off		SO	Snap mode is off
Grid		SG	Nearest grid intersection
Center		SC	Center of a pad (end of an arc or line)
Skeleton		SS	Skeleton hairline in the center of a line or arc, or to the center of a pad
Edge		SE	Closest edge of a feature (also lines and arcs)
Intersect		SI	Intersection of lines or arcs

**Table 18. Snap Modes (continued)**

Snap Mode	Appearance of the Tool	Shortcut	Snap Location
Midpoint		SM	Midpoint of lines (not arcs) or the center of pads and filled surfaces
Profile		SP	Closest point on the defined profile
Between		SB	Center of an orthogonal (horizontal or vertical) line between two closest pads

**Factor 3: Snap Layer**

Snapping only applies to items residing in the Snap layer, as selected with SA (Snap Advance). A small grid symbol indicates that a layer is the Snap layer: ←

**Snap Features**

**Figure 12. Snap Features**

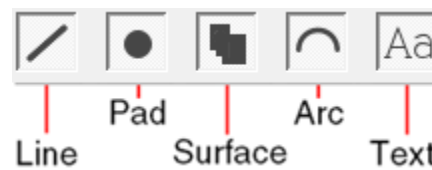







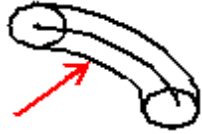

The snap points for a line, pad, surface, or arc depend on the specified Snap mode.

**Table 19. Feature Snap Points Per Snap Mode**



Snap Mode	Line	Pad	Surface	Arc
Center	to ends 	to center 	to center 	to ends 
Skeleton	to skeleton 	to center 	to center 	to skeleton 
Edge	to closest edge 	to closest edge 	to closest edge 	to closest edge 

Table 19. Feature Snap Points Per Snap Mode (continued)

Snap Mode	Line	Pad	Surface	Arc
				
Intersect	to intersect 	no snap 	no snap 	to intersect 
Midpoint	to midpoint 	to center 	to center 	no snap 

## Grid Display

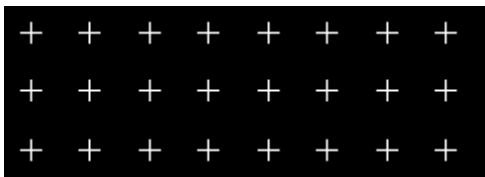
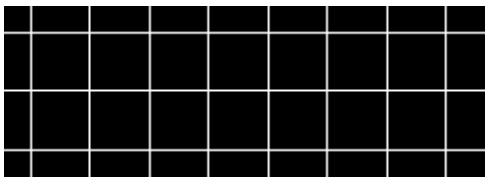
Table 20. Grid Display

Appearance Option	Image
Marks	
Net	
Dots	

## Objects

**Table 21. Snap Dialog Box**

Object	Description
Snap Features	Buttons to exclude features of specified types from snapping. The initial state of the buttons is selected, that is you can snap to features of all types. For example, if you click to deselect the <b>Arc</b> button, then features in the display will not snap to arcs.
Snap Mode	Options to specify Snap mode as described in <a href="#">Table 18: Snap Modes</a> .
Grid	Controls for setting the grid display. <ul style="list-style-type: none"><li>• <b>Off</b> — Displays or hides the grid.</li><li>• <b>Marks</b> — Displays the grid as plus signs (+) at grid intersections.</li><li>• <b>Net</b> — Displays the grid as horizontal and vertical lines.</li><li>• <b>Dots</b> — Displays the grid as dots at grid intersections.</li><li>• <b>X size, Y size</b> — Specify the distances between grid intersections along the X and Y axes.</li></ul>
Origin	Changes the graphic origin to the clicked location in the graphic area. All items in the graphic area are displayed according to the specified origin, without changing the origin of the product model.
Prev Origin	Reverts to the product model origin.

## Related Topics

[Snap Hot Keys](#)

[Measuring Distances](#)



# View Orientation Dialog Box

To access:



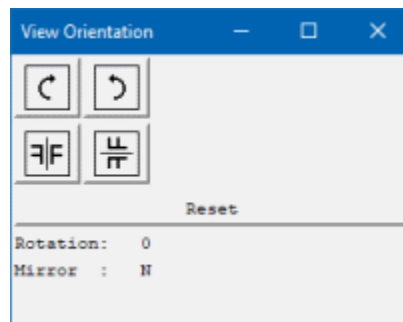

- From Graphic Station: 
- From other viewers: **Actions > View Orientation**

Use the View Orientation dialog box to control the display orientation of the board.

**Figure 13. View Orientation Dialog Box**



## Objects

Object	Description
 Rotate Clockwise	Rotates the board 90 degrees clockwise.
 Rotate Counter-Clockwise	Rotates the board 90 degrees counterclockwise.
 Mirror (Y axis)	Flips the board left to right (left/right mirror).
 Mirror (X axis)	Flips the board top to bottom (mirror top/bottom).
Rotation	Indicates the board rotation.
Mirror	Indicates whether the board has been flipped.

Object	Description
Reset	Returns the display to the original orientation.

### Usage Notes

When rotating or mirroring, the center of the display is always maintained in the center.

# Chapter 5

## Troubleshooting

---

Use this chapter to help fix issues that can occur when working with ODB++Design applications.

[Text Scaling Issues on Windows 10](#)

[Display Colors are Not Correct](#)

[Profile is Not Visible in Graphic Area](#)

## Text Scaling Issues on Windows 10

The menu text may appear too small on high-resolution monitors (such as laptops with 4K resolution).

### Solution

Turn off the setting for fixing blurry apps:

1. Choose **Start > Settings > System > Display**.
2. Under “Scale and layout,” click **Advanced scaling settings**.
3. Under “Fix scaling for apps,” turn off the option “Let Windows try to fix apps so they’re not blurry.”

## Display Colors are Not Correct

Display colors in the Valor NPI Graphic Station are not what you expect.

### Symptoms

- Selected features are not displaying in the chosen color.
- Graphic Station display colors are different from those defined.

### Causes

The color of selected, highlighted, or overlapping features is usually a mixture of the defined display colors.

### Solution

In UNIX, if you want the selection color, highlight color, and rubber band colors to be a separate and consistent color, specify this in configuration parameter `gui_color_no_mix`.

In Windows, when Layer Display Mode = Transparent, layer features are given some transparency and the colors of overlapping features are mixed. This helps to emphasize overlapping features. When Layer Display Mode = Opaque, the colors are not mixed and the color specified for select, highlight, and rubber band is used. See “[Control Dialog Box](#) on page 51” in *Getting Started With ODB++Design*.

## Related Topics

[Configuring the Display](#)

# Profile is Not Visible in Graphic Area

The profile may not display if the highlight color is close to the background color.

## Symptoms

- The profile is not visible in the graphic area.
- Choosing **Edit > Create > Profile** does not seem to create a profile.

## Causes

The profile color might be set to the same color as the background color.

## Solution

Choose **Options > Colors**.

In the Colors dialog box, compare the Background to the Highlight color that controls the profile color. If they are the same, or very close, change one or the other.

## Related Topics

[Configuring the Display](#)

# Glossary of Valor NPI Terms

---

## alias

Alternate name used for a part manufacturer.

## Assembly Merge

Consists of BOM Merge, VPL Merge (also referred to as Library Merge), and Board Merge.

see [BOM Merge](#), [VPL Merge](#), and [Board Merge](#).

## Board Merge

A stage of Assembly Merge that re-engineers EDA data, determining the features and nets connected to each component pin. Same as [Component Linking](#).

see [Assembly Merge](#).

## Board Mark

Marks placed on a board to indicate whether the board can be manufactured (good board mark) or not (bad board mark).

## BOM Merge

A stage of Assembly Merge that merges the BOM with the board.

see [Assembly Merge](#).

## broken

Missing section of an electric circuit.

## BTE

Valor NPI BOM Template Editor. Used to create templates for parsing a customer's BOM input files from their original format. You can use a single template to parse similar BOM files.

## Checklist

Set of DfX Analysis check actions and their results.

## Chosen part

When an IPN has more than one part in the BOM, the Valor NPI BOM Manager chooses one of the parts as the Chosen part. Users can override the system-defined Chosen part.

## Component Identifier

Any of the ways by which a component can be identified, such as: CPN, CAD-CPN, IPN, MPN, Package, RefDes, Station, and Angle.

## Component Linking

Re-engineers EDA data, determining the features and nets connected to each component pin. Component Linking can be performed on a Board or a PCA. Same as [Board Merge](#).

## **contour**

A shape created by merging multiple features.

## **CPN**

Customer Part Number. Represents the part number requested by the customer who provided the design to be manufactured. This can be the same as the IPN or can be mapped to a number of different IPNs, depending on the origin of the CPN.

## **Design Center**

A directory under *\$VALOR\_DIR* that represents a physical plant of the customer who provided the design to be manufactured. The application can be customized for designs coming from a particular design center.

## **DFA**

Design for Assembly. Designing a product so that it can be assembled efficiently at an optimal cost and highest yield.

## **DFF**

Design For Fabrication. Designing a product so that it can be fabricated efficiently at an optimal cost and highest yield.

## **DFM**

Design For Manufacturing. Designing a product so that it can be fabricated efficiently at an optimal cost and highest yield. It is often used to represent both DFA and DFF. The term is used to represent algorithms that can make automated modifications to the PCA based on a set of rules.

## **DFT**

Design For Testing. Designing a product so that electrical tests can be performed. This includes creating points on the outer layers of the board that are used to test how electrical current travels from one point to another through the inner traces of the board.

## **DFx**

Includes all types of Design for eXcellence: Design For Assembly, Design For Fabrication, Design For Manufacturing, Design For Testing.

## **DRC**

Design Rule Check. Pass-or-fail checks based on design constraints. Normally used by EDA vendors.

## **Drill span**

The layers through which a drill passes.

## **Drill type**

A drill attribute with one of these values:

- **Via** — Connects several layers.
- **Non-Plated** — Through-hole (TH) drill type without electrical connectivity.
- **Plated** — Through-hole (PTH) drill type with electrical connectivity. Used for components legs.

## Feature Data

A primitive that can be drawn on the layer: line, pad (a specific symbol flashed at a point), surface (a linear path with a specific width), text.

## Flattening

Displaying all data of a panel with multiple Step & Repeat sequences, as one step. This is necessary for assembly machines that cannot process Step & Repeat information.

## Footprint

The pattern and space on a board taken up by a component, as defined by its body shape and pads (contact area of component legs with the board).

see [Toeprint](#).

## IPN

Internal Part Number. The number used on the assembly floor to identify the parts to be supplied to the machines and put on the boards. The IPN is typically unique for each contract manufacturer.

## Keepin/Keepout Areas

Areas of a layer where components and test points are allowed to be included or excluded, which activates the reporting of components or test points that are located in invalid areas. Keepin/Keepout areas are typically imported with EDA data.

## Layers

Board layers contain graphics, attributes and annotation. Layers represent physical board layers, NC drills and route layers, and miscellaneous drawings. All the boards in one PCA have the same list of layers, although the contents may be different.

## Library Merge

A stage of Assembly Merge that reads package data from the validated BOM, copies VPL packages from the BOM package collection to the PCA package collection, and positions the packages on the PCA at their RefDes location in the correct orientation. Same as [VPL Merge](#).

see [Assembly Merge](#).

## Manufacturer

Name of the supplier of the part, provided in the imported BOM data.

## Manufacturer Alias List

A list in the VPL used to establish the MCode for a manufacturer name listed in the BOM.

For example, the name Duck Instruments might be represented as any of these: Duck Instruments, Duck Instr, D-I, DI.

The manufacturer alias list would list the alias DI for all variations of the manufacturer name:

Manufacturer	MCode
Duck Instruments	DI
Duck Instr	DI
D-I	DI
DI	DI

When the system processes a BOM file, it matches any one of the Duck Instruments name variations with the standard MCode (DI) as defined in the VPL. The result is that the BOM has a consistent Manufacturer name list compatible with the VPL and with VPL-MPN numbers.

### **Matrix**

Represents the layers in a step.

### **MCode**

An abbreviated name used in the VPL to represent all variations of the manufacturer name. The result is that the BOM has a consistent Manufacturer name list compatible with the VPL and with VPL-MPN numbers.

### **MPN**

Manufacturer Part Number. The number used by the manufacturer to identify the part.

### **Net Connectivity**

Information about electrical nets and their reference to actual copper features.

### **ODB++Design (ODB++)**

Open Data Base is a CAD/CAM format that captures all CAD/EDA database, assembly, and PCB fabrication knowledge in a single, unified database.

### **Part Number**

Identifies a component uniquely, within a certain inventory.

### **Part Package**

The geometric characteristics of a component/part. Several parts (unique part numbers) can have the same package.

### **Placement sequencing**

Determining the sequence in which the components are placed on the board.

### **Polarized**

This BOM column indicates whether the orientation of the part is significant.



## Preference

A rating for each alternate MPN of an IPN, to indicate which is preferred: Preferred, Qualified, Unknown (default), NotQualified. This information is used to establish the Chosen part among alternate MPNs for an IPN.

## Profile

The PCB outline, typically defined in the CAD data and imported with the product model. It is normally defined as the outline of the PCB and follows the route path.

## Recommended pads

Parts for which pin contact area data is not available, and recommended pads are proposed instead. You can specify whether packages with recommended pads are included. An asterisk is added to the end of the name in the BOM Manager if the package contains recommended pads (for example, PDSO-C2/XX-L58W45T31\*).

## Same Net Spacing

Reports non-touching, non-text features belonging to the same layer which are closer than a predefined parameter.

## Set Origin

After importing a CAD design, you can set the board origin to a different point. The origin can be set at a corner, or any other point on the board. Changing the origin offsets the coordinates of all features in the graphic display.

## SIP

Self-Intersecting Polygon.

## Slivers in copper planes

Areas in which the spacing between two lines or a line and a component is so close that they can potentially cause shorts. Slivers can also be formed in the etch resist when a trace leaves a termination at an acute angle. This sliver can then lift, causing a violation.

## Stubs

Unconnected line endpoints.

## Toeprint

The pad of one leg of a component. A footprint is made up of a number of toeprints.

see [Footprint](#).

## Tooling

Items unique to the PCB design that are necessary for manufacturing such as films, drilling and routing data, and text fixtures.

## VLM

The VPL Manager (VLM) application manages a local VPL database and the content retrieved from the central Mentor Graphics VPL. VLM provides tools to search, modify, create, and update the VPL database and its contents.

The VPL is typically accessed by specifying a component identifier, which includes the component Manufacturer and the Manufacturer Part Number (MPN). The connection between manufacturer data, part data and package data is maintained by the MCode and VPackage Name that are stored in each part definition.

## VPL

The Valor Part Library is a database containing the physical descriptions of components.

Replacing CAD-drawn component packages with geometrically accurate component packages ensures accurate Design for Assembly (DFA) checks such as those performed using Valor products. In addition, the accurate geometry serves as a basis for the Auto-Generation of SMT Machine part data.

The VPL provides accurate physical models of electronic components supporting footprint generation, DFM, and NPI (New Product Introduction) operations. It includes VPL Manufacturers and VPL-MPNs. You can work with a local VPL and with the remote VPL at Mentor Graphics.

## VPL Manufacturer

Name of the manufacturer in the BOM after retrieval from the VPL.

## VPL Merge

A stage of Assembly Merge that reads package data from the validated BOM, copies VPL packages from the BOM package collection to the PCA package collection, and positions the packages on the PCA at their RefDes location in the correct orientation. Same as [Library Merge](#).

see [Assembly Merge](#).

## VPL Package

Name of package in the BOM after retrieval from the VPL. This information is used to establish the Chosen part among alternate MPNs for an IPN.

# Glossary of Electronics Industry Terms

---

## Aperture file

A Gerber wheel file contains external Gerber information as lines of text, each representing one or more Dcode descriptions. Dcodes contain the symbol information missing from the Gerber files, because Gerber 274D files refer only to position. Gerber 274X has the aperture file embedded in the layer files, making the aperture file unnecessary.

see [Dcode](#).

## Artwork

An accurately scaled configuration used to produce the artwork master or production master.

## Assembly

The process of attaching electronic components to a PCB to create a PCA.

see also [Fabrication](#).

## AVL

Approved Vendor List. A list of alternate (functionally equivalent) parts for each CPN that are acceptable to the customer. At minimum, the list includes CPN, Vendor, MPN, with a relationship of many Vendor/MPN combinations per CPN. The AVL can be part of the BOM or a separate file. If the BOM data and AVL data are provided in separate files, you can import them to the same PCA and merge them.

see also [BOM](#), [CPL](#).

## axial

Components whose two pins extend from opposite sides of the body along the horizontal axis of the body.

see also [radial](#).

## BGA

Components that have all their terminations on the bottom.

see also [Component](#), [DIP components](#).

## Board

Contains all the information associated with a printed circuit design.

see [Route](#).

## Body

Main part of an electronic component, excluding its pins.

## **BOM**

Bill of Materials. A list of parts to be placed on a board with details identifying each part and its placement on the board. Normally contains Customer Part Number (CPN) and component location on the board (Reference Designator).

see also [AVL](#), [CPL](#).

## **Bottom**

The bottom side of a PCB.

see also [Top](#).

## **Bridging**

Unwanted electrical connectivity between two pads.

## **Broken net**

An open net where a section has been disconnected.

## **CAD**

Computer Aided Design. CAD data describes the locations of holes and conductors in terms of X and Y coordinates, hole sizes, and others. It can contain electrical information and netlists. CAD data has more comprehensive information than CAM data. Shapes are recognizable, self-contained entities instead of being a collection of lines.

see [CAM](#), [EDA](#).

## **CAM**

Computer Aided Manufacturing or Computer Assisted Manufacturing. Technology in which machinery receives instructions from a computer. Often this data is in Gerber format. When CAD output is fed into the CAM device and translated into instructions to the machinery, it is called CAD/CAM.

see [CAD](#), [EDA](#).

## **Component**

Electronic part attached to a PCB during PCA assembly.

see also [BGA](#), [DIP components](#), .

## **Copper balancing**

Balancing the distribution of the copper density throughout and across the PCB to prevent bowing and twisting during thermal processing.

## **CPL**

Component Placement List. Holds the X, Y, angle, and side information for each RefDes to indicate placement on the board.

see also [AVL](#), [BOM](#).

## Dcode

The link between a symbol description and a specific aperture code in a Gerber file. This is defined in a wheel. Dcodes control whether the light is on or off, and represent the aperture position on a list or wheel.

see [Aperture file](#).

## DIP components

Dual Inline Packages. Components that have two parallel rows of pins. The term started with through hole insertion DIPs such as Proms, processors which had two rows of pins that inserted into holes. SMT DIPs are more commonly referred to as SOICs—Small Outline Integrated Circuits and other similar packages.

see also [Component](#), [BGA](#), .

## EDA

Electronic Design Automation. Formats from which the application can receive CAD data.

see [CAD](#), [CAM](#).

## Fabrication

The work done as part of the actual fabrication of the copper layers and other actions performed on a board before it is ready to receive parts (Drill, Signal, Solder Paste, Solder Mask, and others).

see also [Assembly](#).

## Feeder

A tool used to deliver parts supplied in a reel to an SMT machine.

see [Feeder Capacity](#).

## Feeder Capacity

The number of feeder slots available on a machine.

see [Feeder](#).

## Fiducial

A marking at any point on the board with no electrical importance (not in the netlist) that is recognized optically by the assembly machine.

Assists in the optical alignment of an assembly machine to the board. It can help compensate for slight rotations of the board and in accurate placement of the component. There are three types of fiducials:

- **Local fiducial** — Relates to a component
- **Global fiducial** — Relates to a layer
- **Panel** — Relates to a panel

## footprint

The configuration of pads for all pins of a specific component.

## HDI

High Density Interconnect. Boards that use high density methods, such a micro-via, additive technologies, and others.

## Inspection

Manual or AOI/AXI automated visual verification of quality, without electrical testing.

## IPC

The Institute for Interconnecting and Packaging Electronic Circuits. The final American authority on how to design and manufacture printed wiring.

## Lead

The pin of a component. Same as *Pin*.

## Line

Ordered collection of assembly machines with their parameters.

## mount-type

How an electronic component is attached to a PCB.

see *technology*, *SMT*, *through-hole*.

## NC

Assembly machine programming data in ASCII or binary format. NC program files are output from auto-assembly sessions.

## Netlist

Net points and their connectivity definition, normally from the schematic.

## Nozzle

The part of the head on an assembly machine that picks up the parts from the feeder and lets go when they are in place on the board.

## NPI

New Product Introduction is the process used to handle new products at the assembly factory or designer when the first arrive, to check that the boards can be assembled with minimal errors.

## NPTH

Non-Plated Through Hole.

see also *PTH*, *Via holes*.

## OEM

Original Equipment Manufacturer. The original designer of a product or the company that has its label on the product (for example, Sony, Cisco, Dell).

## Package

Definition of the physical dimensions of an electronic component, without taking into consideration its electrical properties.

## pad

A flat surface used to make electrical contact between a surface mount device and a PCB.

see also [trace](#).

## Panel

A sheet of PCB containing several (similar or different) units that will be broken into individual boards by a break operation. Same as [step&repeat](#), [S&R](#).

## Part

An electronic component to be attached to a PCB during assembly to produce a PCA.

## PCA

Printed Circuit Assembly. Created by integrating BOM/AVL data with a board. You can create an empty PCA and attach a board, or you can create a PCA from a board (you can create it with no BOM if you are importing a separate BOM, or you can create it with a generated BOM extracted from the CAD part numbers). The PCA is stored under a particular customer and design center.

## PCB

Printed Circuit Board. A board typically made from fiberglass, used for mounting electronic components. This board, also called a printed wiring board (PWB), has wiring patterns formed by traces of a conductor, such as copper, fused to the board. These traces provide electrical connections for components that are mounted on the surface of the PCB or through holes in the PCB. Examples: motherboard, SIMM, credit card memory.

## Pin

A terminal on a component, whether SMT or through-hole. Also called a lead. Ball technology components (such as BGSs, CSPs, and others) have ball terminations in place of pins. Same as [Lead](#).

## Pin One

The pin that indicates the orientation of the component.

see [Pin](#).

## Pinhole

Small copperless gaps surrounded on all sides by copper. Pinholes might cause electrical breaks, decreased connectivity or undesirable electrical effects.

## Pitch

Distance between the centers of a component's pins.

see [Pin](#).

## Power and Ground Layers

(P&G layers) Layers of copper that are fed by electrical voltage or are grounded.

see [stackup](#), [Solder mask](#).

## PTH

Pin through-hole or plated through hole.

see also [NPTH](#), [Via holes](#).

## radial

Components whose leads extend from the same side of the component and whose pins usually form a single line.

see also [axial](#).

## RefDes

Reference Designator. The unique name of a placed component. Each CPN can be placed several times on a PCB; each placement has a unique RefDes.

## Rotation

The orientation of a component on the PCA.

## Route

The line on which a PCA is cut to separate it from a board or panel.

see [Board](#).

## Shorted net

A net that is erroneously connected to another net.

## SMD

Surface Mounted Device. A part put on the board which does not fit into any drill holes but rather connects to pads on the board.

## SMT

Surface Mount Technology. A method for attaching components to a PCA by placing them on the surface of a PCB and then creating solder joints between the component's leads and the copper pads. Usually the solder joints are created by placing the components on solder paste that has been screened on the PCB and then passing it through a reflow oven. Alternately, the components can be glued to the board and then the PCB can be passed through a wave solder machine.

## SMT Programming

The process of creating all the information required for an SMT machine to place all the required components on a PCA. This includes the placement sequence information, the machine shape information, and the feeder set-up data.

## Solder mask

Plastic material spread on the copper of a circuit board except where the copper should be exposed, such as the contacts to be soldered, the gold-plated terminals of any card-edge connectors, and fiducial marks.

see [stackup](#), [Power and Ground Layers](#).



## stackup

The layers of a board arranged according to a specific order.

see [Solder mask](#), [Power and Ground Layers](#).

## step&repeat

The repetition of a board on a panel. Same as [Panel](#), [S&R](#).

## S&R

The repetition of a board on a panel. Same as [Panel](#), [step&repeat](#).

## technology

Type of component: MECH, SMT, THT.

see [mount-type](#), [SMT](#), [through-hole](#).

## Thieving Pad - Copper

When copper features are placed on the outside of the board away from any other copper features (such as fiducials), these will plate excessively during the pattern plating process. To reduce this, dummy copper feature (or cross hatch patterns) will be placed close by, to thief this excess plating and even out the flux density in plating.

see also [Thieving Pad - Solder](#).

## Thieving Pad - Solder

When wave soldering leaded SMT devices (such as SOICs) on the bottom of a PCB, a solder bridge will often form between the last two leads of the device as it exits the wave. To prevent this, solder thieves are placed on the board at the rear of the SOIC to thief this excess solder away, preventing the bridge.

see also [Thieving Pad - Copper](#).

## trace

A line or arc forming a part of the electrical circuit.

see also [pad](#).

## through-hole

THT technology assembly method of fitting wire leads of components into holes in the PCB. In the industry, SMT has largely replaced THT.

see [mount-type](#), [SMT](#), [technology](#).

## Top

Top surface of a board.

see also [Bottom](#).

## Via holes

A hole of one of these types:

- **Through** — From top to bottom.
- **Blind** — Drilled from one side, ending before reaching the other side. Cannot be seen from one of the sides of the board.
- **Buried** — Connects two or more layers in the middle. It cannot be seen from either side of the board. This is done by drilling the hole before the layers are attached.

*see also [NPTH](#), [PTH](#).*